

Important!

Please Read Before Starting

This air conditioning system meets strict safety and operating standards. As the installer or service person, it is an important part of your job to install or service the system so it operates safely and efficiently.

For safe installation and trouble-free operation, you must:

- Carefully read this instruction booklet before beginning.
- Follow each installation or repair step exactly as shown.
- Observe all local, state, and national electrical codes.
- Pay close attention to all warning and caution notices given in this manual.



WARNING

This symbol refers to a hazard or unsafe practice which can result in severe personal injury or death.



CAUTION

This symbol refers to a hazard or unsafe practice which can result in personal injury or product or property damage.

If Necessary, Get Help

These instructions are all you need for most installation sites and maintenance conditions. If you require help for a special problem, contact our sales/service outlet or your certified dealer for additional instructions.

In Case of Improper Installation

The manufacturer shall in no way be responsible for improper installation or maintenance service, including failure to follow the instructions in this document.

Special Precautions

WARNING

When Wiring



ELECTRICAL SHOCK CAN CAUSE SEVERE PERSONAL INJURY OR DEATH. ONLY A QUALIFIED, EXPERIENCED ELECTRICIAN SHOULD ATTEMPT TO WIRE THIS SYSTEM.

- Do not supply power to the unit until all wiring and tubing are completed or reconnected and checked.
- Highly dangerous electrical voltages are used in this system. Carefully refer to the wiring diagram and these instructions when wiring. Improper connections and inadequate grounding can cause accidental injury or death.
- Ground the unit following local electrical codes.
- Connect all wiring tightly. Loose wiring may cause overheating at connection points and a possible fire hazard.

When Transporting

Be careful when picking up and moving the indoor and outdoor units. Get a partner to help, and bend your knees when lifting to reduce strain on your back. Sharp edges or thin aluminum fins on the air conditioner can cut your fingers.

When Installing...

...In a Ceiling or Wall

Make sure the ceiling/wall is strong enough to hold the unit's weight. It may be necessary to construct a strong wood or metal frame to provide added support.

...In a Room

Properly insulate any tubing run inside a room to prevent "sweating" that can cause dripping and water damage to walls and floors.

...In Moist or Uneven Locations

Use a raised concrete pad or concrete blocks to provide a solid, level foundation for the outdoor unit. This prevents water damage and abnormal vibration.

...In an Area with High Winds

Securely anchor the outdoor unit down with bolts and a metal frame. Provide a suitable air baffle.

...In a Snowy Area (for Heat Pump-type Systems)

Install the outdoor unit on a raised platform that is higher than drifting snow. Provide snow vents.

When Connecting Refrigerant Tubing

- Use the flare method for connecting tubing.
- Apply refrigerant lubricant to the matching surfaces of the flare and union tubes before connecting them, then tighten the nut with a torque wrench for a leak-free connection.
- Check carefully for leaks before starting the test run.

When Servicing

- Turn the power off at the main power box (mains) before opening the unit to check or repair electrical parts and wiring.
- Keep your fingers and clothing away from any moving parts.
- Clean up the site after you finish, remembering to check that no metal scraps or bits of wiring have been left inside the unit being serviced.

Others



CAUTION

- Ventilate any enclosed areas when installing or testing the refrigeration system. Escaped refrigerant gas, on contact with fire or heat, can produce dangerously toxic gas.
- Confirm upon completing installation that no refrigerant gas is leaking. If escaped gas comes in contact with a stove, gas water heater, electric room heater or other heat source, it can produce dangerously toxic gas.
- Do not install only on a single indoor unit.

Table of Contents

	Page
1. OPERATING RANGE	1
2. SPECIFICATIONS	
2-1. Unit Specifications	2
2-2. Major Component Specifications.....	3
2-3. Other Component Specifications.....	4
3. DIMENSIONAL DATA	5
4. REFRIGERANT FLOW DIAGRAM	6
5. PERFORMANCE DATA	
5-1. Performance Charts (4-room multi)	7
6. ELECTRICAL DATA	
6-1. Electric Wiring Diagram	11
7. INSTALLATION INSTRUCTIONS	
7-1. Indoor Unit	12
7-2. Outdoor Unit	14
7-3. Diagram of Outdoor Unit Installation	15
7-4. Recommended Wire Length and Diameter	16
7-5. Wiring System Diagram.....	16
8. FUNCTIONS	
8-1. Defrost Detection and End	17
8-2. Current Control	18
8-3. Low Start Current	18
8-4. Compressor Temperature Control	18
8-5. Outdoor Fan Control	18
8-6. Control at HEAT Start-up	19
9. TROUBLESHOOTING	
9-1. Conditions That Do Not Represent Trouble	20
9-2. Outdoor Unit Trouble Diagnostics	21
9-3. Checking the Outdoor System	22
9-4. Unit Problems and Inspection Points	23
9-5. Explanation of Functions	26
10. REFRIGERANT R410A: SPECIAL PRECAUTIONS WHEN SERVICING UNIT	
10-1. Characteristics of New Refrigerant R410A.....	30
10-2. Checklist Before Servicing.....	30
10-3. Tools Specifically for R410A	32
10-4. Tubing Installation Procedures	32
10-5. In Case of Compressor Malfunction	33
10-6. In Case Refrigerant is Leaking	35
10-7. Charging Additional Refrigerant	37
10-8. Retro-Fitting Existing Systems	37
APPENDIX	38

1. OPERATING RANGE

	Temperature	Indoor Air Intake Temp.	Outdoor Air Intake Temp.
Cooling	Maximum	32°C D.B. / 23°C W.B.	43°C D.B.
	Minimum	19°C D.B. / 14°C W.B.	19°C D.B.
Heating	Maximum	27°C D.B.	24°C D.B. / 18°C W.B.
	Minimum	16°C D.B.	— / -15°C W.B.

2. SPECIFICATIONS

2-1. Unit Specifications

Outdoor Unit **AE4MI91AH**

Type		4-room multi outdoor unit			
Number of connectable indoor units		4			
Maximum capacity of connected indoor units kW		15.4			
Maximum capacity of operating indoor units kW		15.4			
Power Source		220~240V ~ 50Hz		220V ~ 60Hz	
Voltage rating		230V		220V	
Performance		Cooling	Heating	Cooling	Heating
Capacity	kW	9.0 (1.2 - 10.5)	10.0 (1.7 - 10.8)	9.0 (1.2 - 10.5)	10.0 (1.7 - 10.8)
	BTU/h	30,700	34,100	30,700	34,100
Air circulation (High)		m ³ /h		2,800	
Electrical Rating		Cooling	Heating	Cooling	Heating
Available voltage range		V		198 ~ 264	
Running amperes		A		198 ~ 242	
Power input		W		8.8 (Max.15.5)	
Power factor		%		9.7 (Max.16.5)	
C.O.P.		W/W		1,940	
Starting amperes		A		2,170	
Features		Microprocessor			
Controls		Auto (Hi, Lo)			
Fan speeds		Twin Rotary (DC inverter)			
Compressor		R410A / 4,000			
Refrigerant / Amount charged at shipment		g			
Refrigerant control		Electric Expansion Valve			
Operation sound		Hi	dB-A	53	54
Refrigerant tubing connections		Flare type			
Max. allowable tubing length per unit		m			
Refrigerant		30			
tube diameter		Narrow tube	mm (in.)	6.35(1/4) × 4	
		Wide tube	mm (in.)	9.52(3/8) × 3	
			mm (in.)	12.7(1/2) × 1	
Dimensions & Weight					
Unit dimensions	Height	mm	880		
	Width	mm	940		
	Depth	mm	340		
Package dimensions	Height	mm	981		
	Width	mm	1,016		
	Depth	mm	440		
Weight	Net	kg	90		
	Shipping	kg	92		
Shipping volume		m ³	0.44		

DATA SUBJECT TO CHANGE WITHOUT NOTICE.

Remarks:

- The values shown in performance section and electrical rating section above are based on the following unit combination. For other combination of indoor units, please refer to the "Unit Combination Table" in this manual.

Indoor units : AVMI28AHL4 units
(Outdoor unit : AE4MI91AH 1 unit)

- Rating conditions are:

Cooling : Indoor air temperature 27°C D.B. / 19°C W.B.
Outdoor air temperature 35°C D.B. / 24°C W.B.
Heating : Indoor air temperature 20°C D.B.
Outdoor air temperature 7°C D.B. / 6°C W.B.

2-2. Major Component Specifications

2-2-1. Outdoor Unit

Outdoor Unit **AE4MI91AH**

Control PCB / HIC PCB / Filter PCB		POW-CM5A1-C-T / CR-HIC50A2-C-T / POW-CM5B1-C-T	
Compressor			
Type	DC Twin Rotary (Hermetic)		
Compressor model	C-9RVN273H0W 80867080		
Compressor oil ... Amount	cc	FVC68S ... 1900	
Coil resistance (Ambient temp. 25°C)	Ω	R – S: 0.169 S – T: 0.169 T – R: 0.169	
Safety devices			
CT (Peak current cut-off control)	YES		
Compressor discharge temp. control	YES		
Operation cut-off control in abnormal ambient temp.	—		
Run capacitor	μF	—	
	VAC	—	
Crankcase heater	25W 240V		
Fan & Fan Motor			
Type	Propeller		
Q'ty ... Dia.	mm	1 ... ø460	
Fan motor model ... Q'ty	KFC6S-61C3PA-C ... 1		
No. of poles ... rpm (220V, High)	6 ... 712		
Nominal output	W	60	
Coil resistance (Ambient temp. 20°C)	Ω	BRN – WHT: 66.53 WHT – YEL: 33.95 YEL – PNK: 12.50	
Safety devices	Type	Thermal protector	
Operating temp.	Open	°C	130 ± 8
	Close	°C	79 ± 15
Run capacitor	μF	5	
	VAC	440	
Heat Exchanger Coil			
Coil	Aluminum plate fin / Copper tube		
Rows	2		
Fin pitch	mm	1.4	
Face area	m ²	0.630	
External Finish		Acrylic baked-on enamel finish	

DATA SUBJECT TO CHANGE WITHOUT NOTICE.

2-3. Other Component Specifications

Outdoor Unit SAP-CMRV3143GJH

• Compressor temp sensor

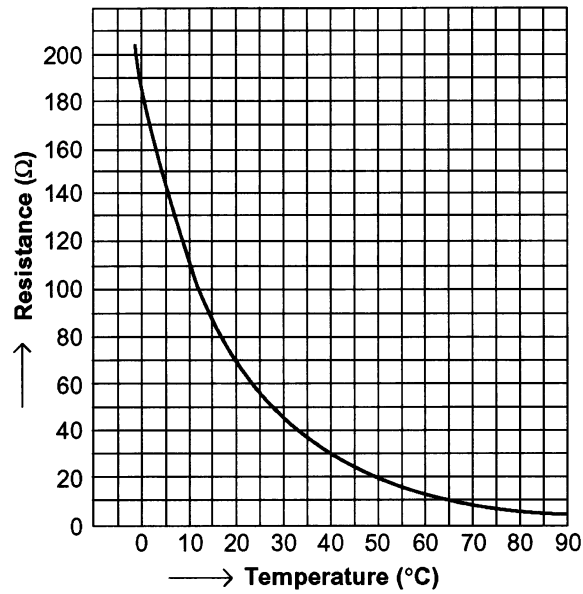

- Outdoor air temp sensor
- Outdoor heat exchanger sensor
- Narrow tube sensor
- Wide tube sensor

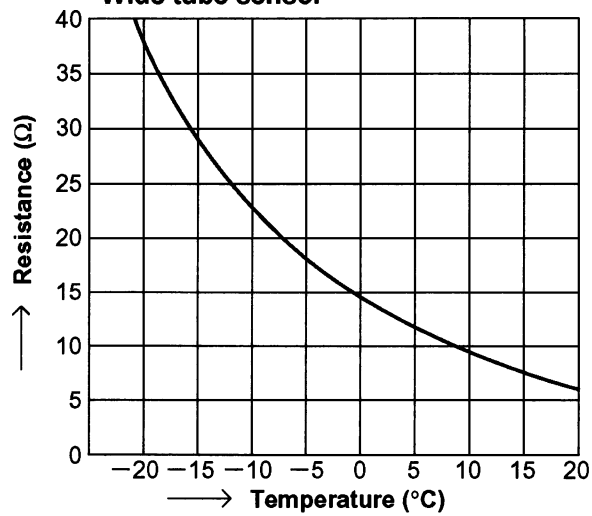

3. DIMENSIONAL DATA

Outdoor Unit **AE4MI91AH**

Unit: mm

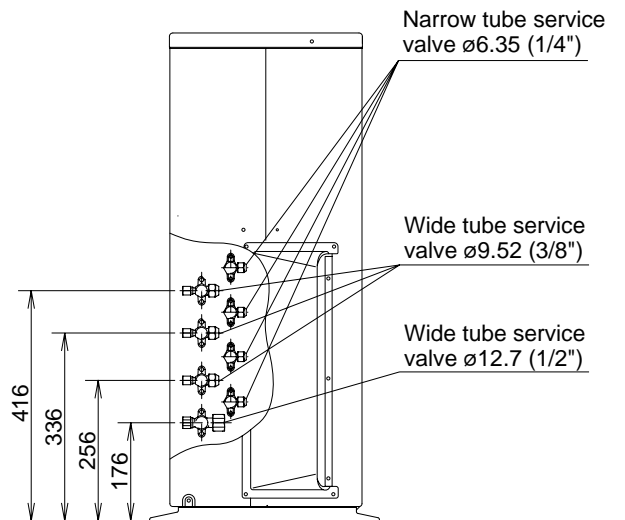
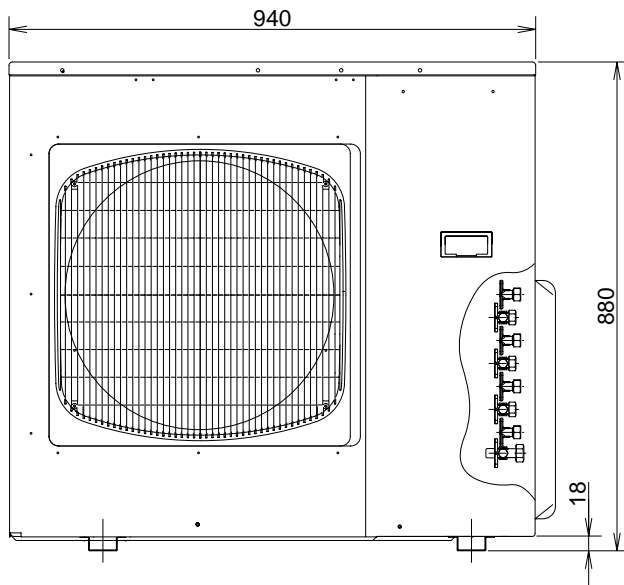
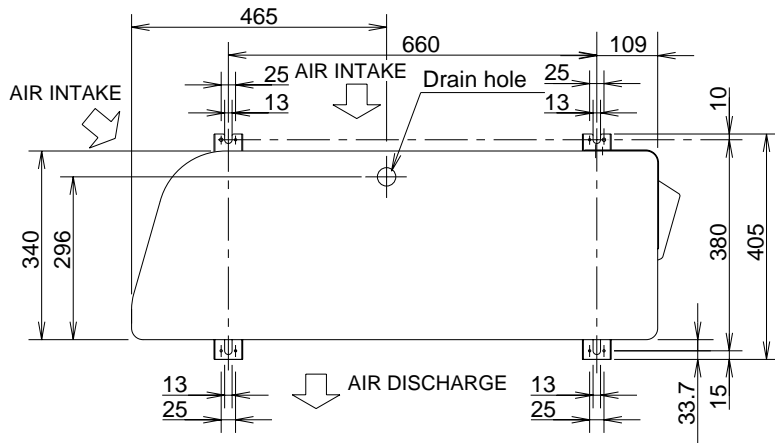

4. REFRIGERANT FLOW DIAGRAM

Outdoor Unit **AE4MI91AH**

4-Room Multi-Refrigerant Tubing System Diagram

Unit: mm

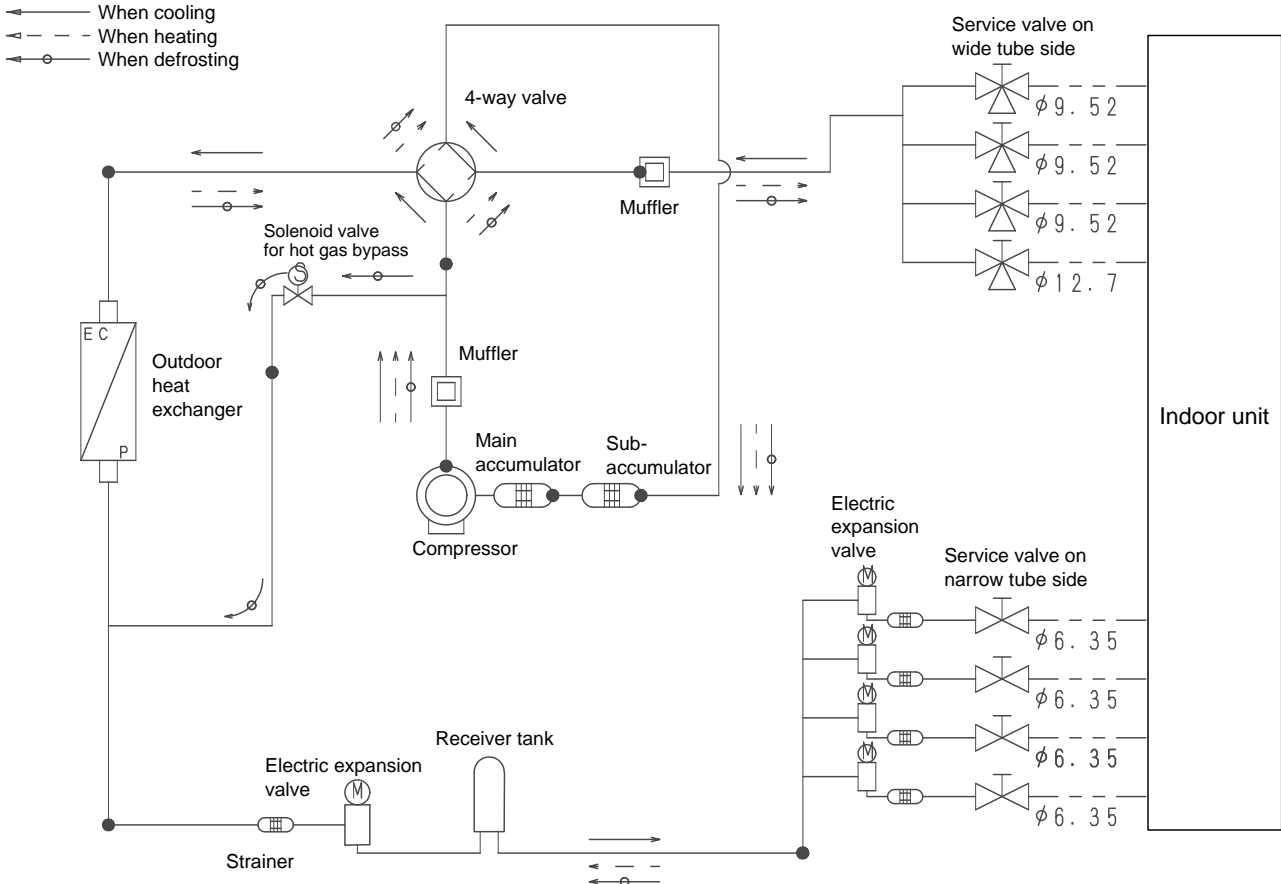

Insulation of Refrigerant Tubing

IMPORTANT

Because capillary tubing is used in the outdoor unit, both the wide and narrow tubes of this air conditioner become cold. To prevent heat loss and wet floors due to dripping of condensation, **both tubes must be well insulated** with a proper insulation material. The thickness of the insulation should be a min. 8 mm.

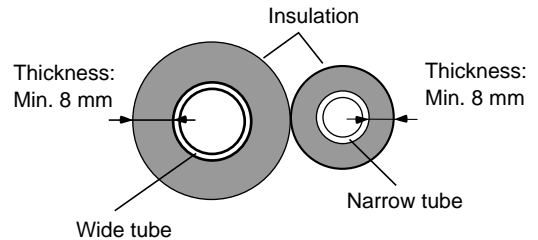

CAUTION

After a tube has been insulated, never try to bend it into a narrow curve because it can cause the tube to break or crack.

5. PERFORMANCE DATA

5-1. Performance Charts (4-room multi)

Outdoor Unit **AE4MI91AH**

Indoor Unit **AWMI28AHL × 1**

• Cooling Characteristics

(1) Low pressure performance chart
(RH: 46%, Indoor fan speed: High fan)
(50/60Hz, 220V)

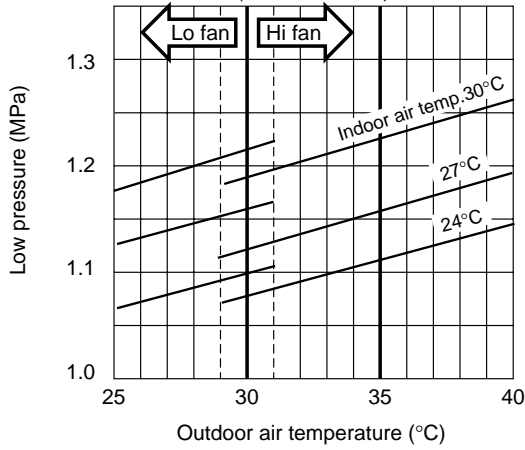

(2) Operating current performance chart
(RH: 46%, Indoor fan speed: High fan)
(50/60Hz, 220V)

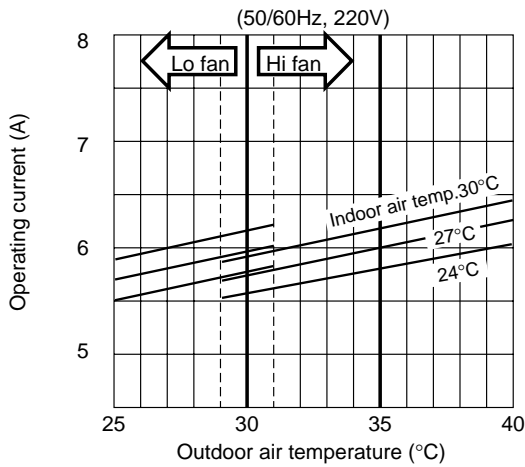

(3) Indoor discharge air performance chart
(RH: 46%, Indoor fan speed: High fan)
(50/60Hz, 220V)

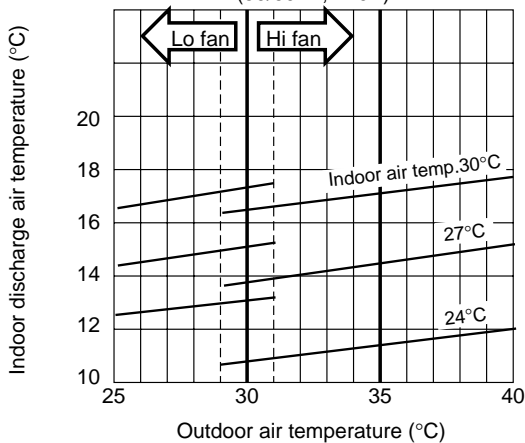

• Heating Characteristics

(1) High pressure performance chart
(RH: 85%, Indoor fan speed: High fan)
(50/60Hz, 220V)

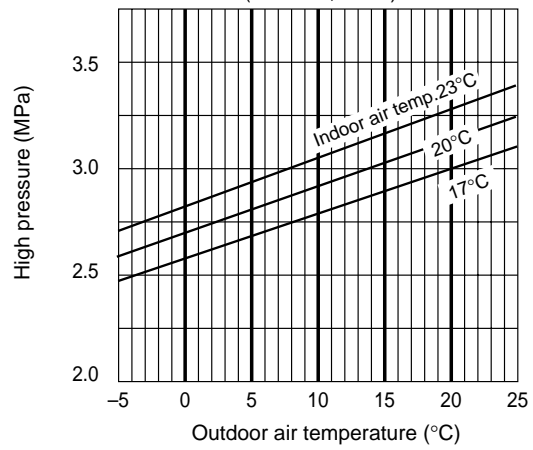

(2) Operating current performance chart
(RH: 85%, Indoor fan speed: High fan)
(50/60Hz, 220V)

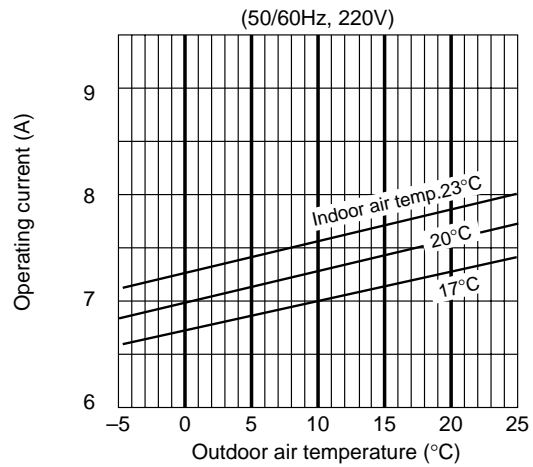

(3) Indoor discharge air performance chart
(RH: 85%, Indoor fan speed: High fan)
(50/60Hz, 220V)

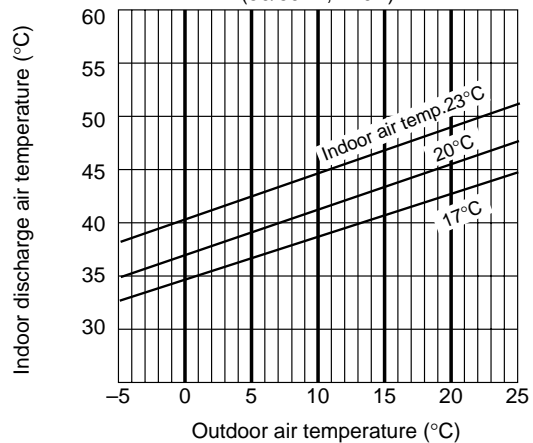

NOTE

- This performance chart shows operation of a single wall-mounted indoor unit. The performance chart will vary depending on the indoor unit type.
- Check each performance value in test-run mode. Electrical performance values represent a combined indoor/outdoor value. (In this case, be sure to stop all the indoor units where performance is not being checked.)
- The performance is for a tubing length of 7.5 m. If the tubing length is different, the performance chart will vary.

Outdoor Unit **AE4MI91AH**
 Indoor Unit **AWMI38AHL × 1**

• **Cooling Characteristics**

(1) Low pressure performance chart
 (RH: 46%, Indoor fan speed: High fan)
 (50/60Hz, 220V)

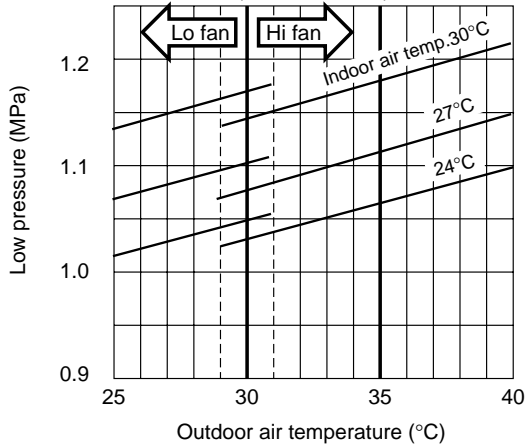

(2) Operating current performance chart
 (RH: 46%, Indoor fan speed: High fan)
 (50/60Hz, 220V)

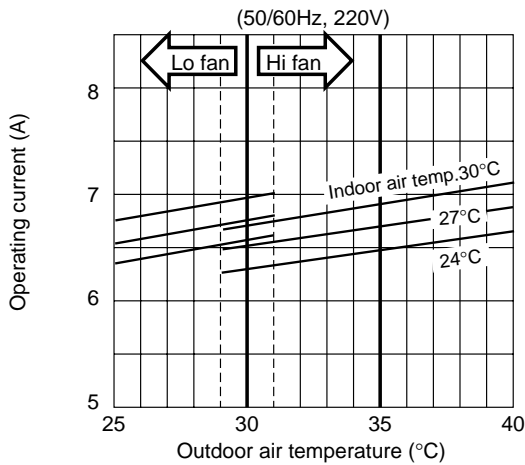

(3) Indoor discharge air performance chart
 (RH: 46%, Indoor fan speed: High fan)
 (50/60Hz, 220V)

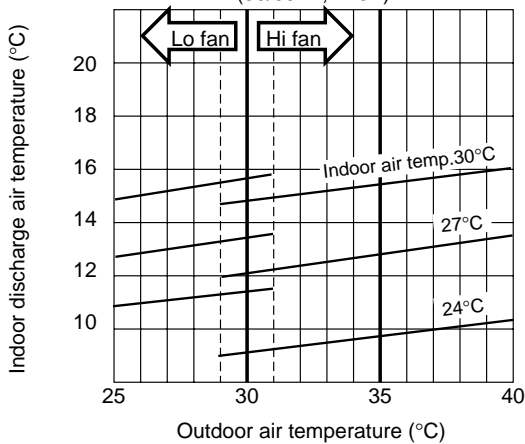

• **Heating Characteristics**

(1) High pressure performance chart
 (RH: 85%, Indoor fan speed: High fan)
 (50/60Hz, 220V)

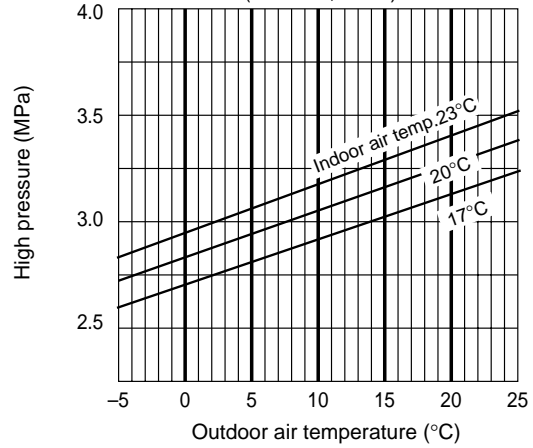

(2) Operating current performance chart
 (RH: 85%, Indoor fan speed: High fan)
 (50/60Hz, 220V)

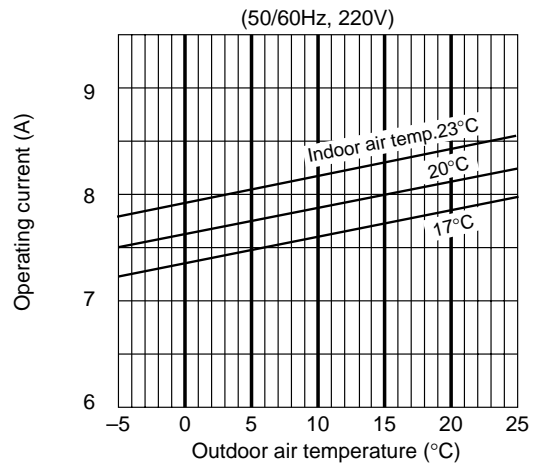

(3) Indoor discharge air performance chart
 (RH: 85%, Indoor fan speed: High fan)
 (50/60Hz, 220V)

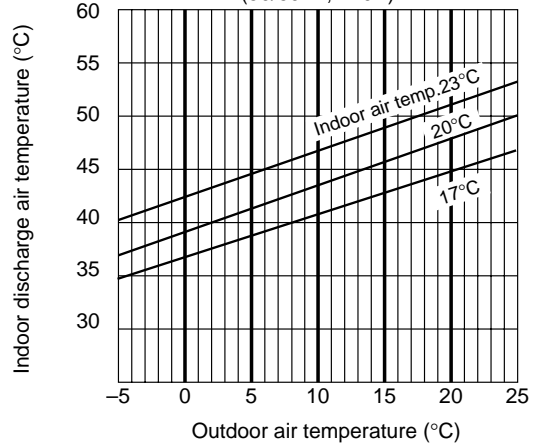

- NOTE**
- This performance chart shows operation of a single wall-mounted indoor unit. The performance chart will vary depending on the indoor unit type.
 - Check each performance value in test-run mode. Electrical performance values represent a combined indoor/outdoor value. (In this case, be sure to stop all the indoor units where performance is not being checked.)
 - The performance is for a tubing length of 7.5 m. If the tubing length is different, the performance chart will vary.

Outdoor Unit **AE4MI91AH**
 Indoor Unit **AWMI50AHL × 1**

• **Cooling Characteristics**

(1) Low pressure performance chart
 (RH: 46%, Indoor fan speed: High fan)
 (50/60Hz, 220V)

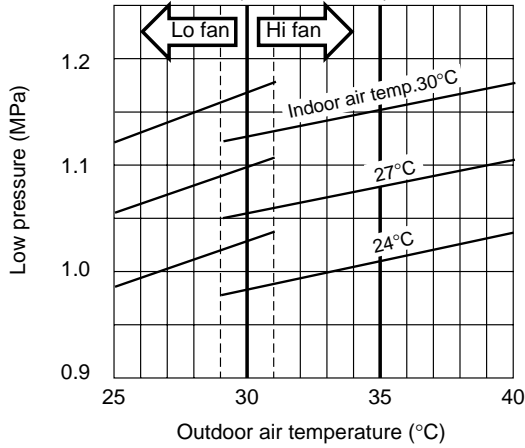

(2) Operating current performance chart
 (RH: 46%, Indoor fan speed: High fan)
 (50/60Hz, 220V)

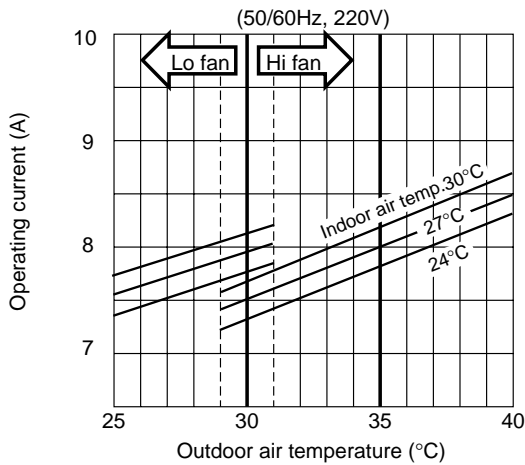

(3) Indoor discharge air performance chart
 (RH: 46%, Indoor fan speed: High fan)
 (50/60Hz, 220V)

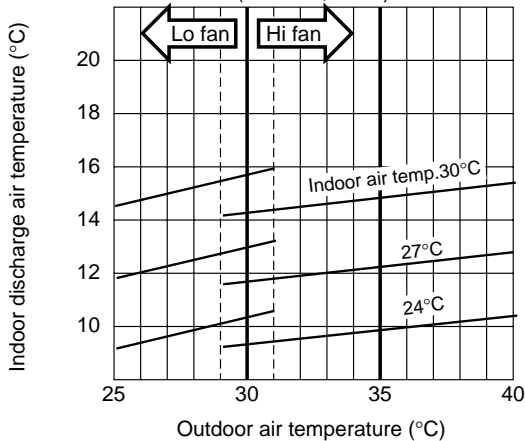

• **Heating Characteristics**

(1) High pressure performance chart
 (RH: 85%, Indoor fan speed: High fan)
 (50/60Hz, 220V)

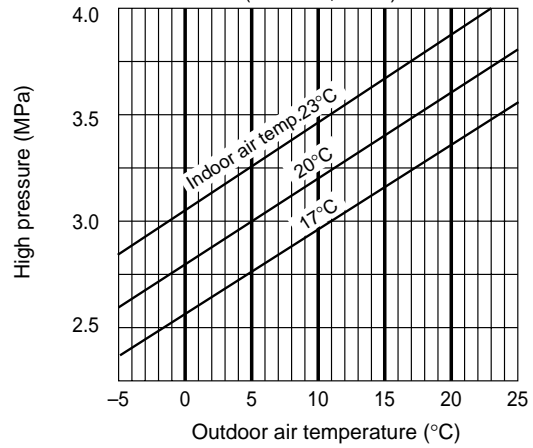

(2) Operating current performance chart
 (RH: 85%, Indoor fan speed: High fan)
 (50/60Hz, 220V)

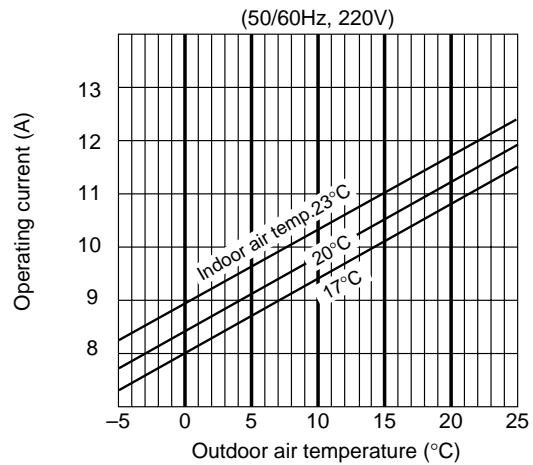

(3) Indoor discharge air performance chart
 (RH: 85%, Indoor fan speed: High fan)
 (50/60Hz, 220V)

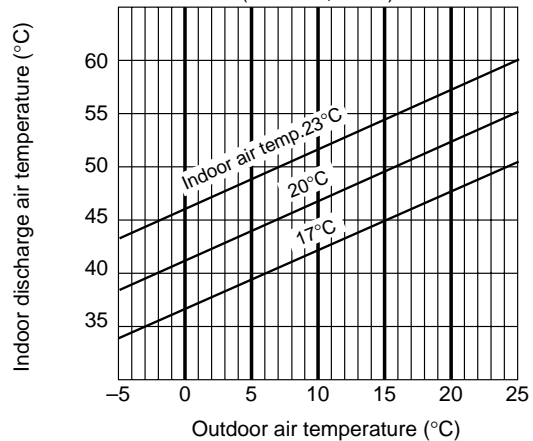

NOTE

- This performance chart shows operation of a single wall-mounted indoor unit. The performance chart will vary depending on the indoor unit type.
- Check each performance value in test-run mode. Electrical performance values represent a combined indoor/outdoor value. (In this case, be sure to stop all the indoor units where performance is not being checked.)
- The performance is for a tubing length of 7.5 m. If the tubing length is different, the performance chart will vary.

Outdoor Unit **AE4MI91AH**
 Indoor Unit **AWMI70AHL × 1**

• **Cooling Characteristics**

(1) Low pressure performance chart
 (RH: 46%, Indoor fan speed: High fan)
 (50/60Hz, 220V)

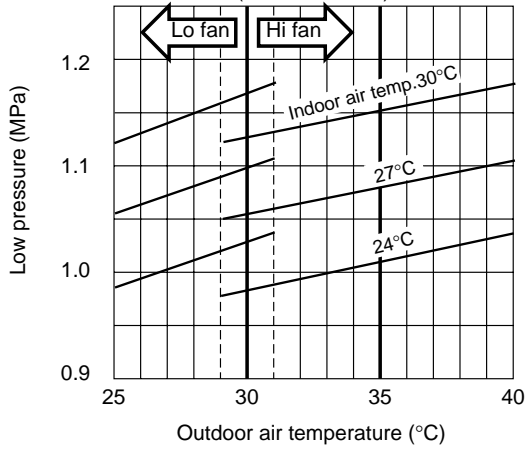

(2) Operating current performance chart
 (RH: 46%, Indoor fan speed: High fan)
 (50/60Hz, 220V)

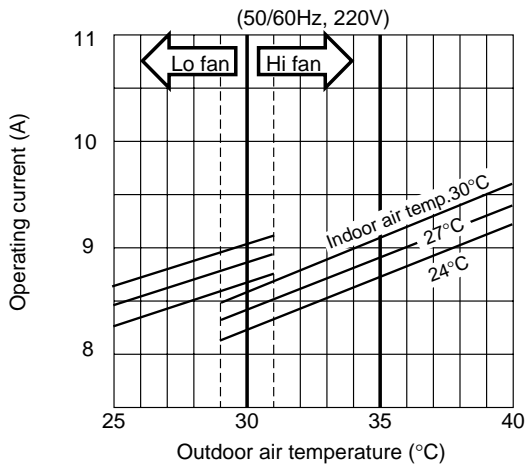

(3) Indoor discharge air performance chart
 (RH: 46%, Indoor fan speed: High fan)
 (50/60Hz, 220V)

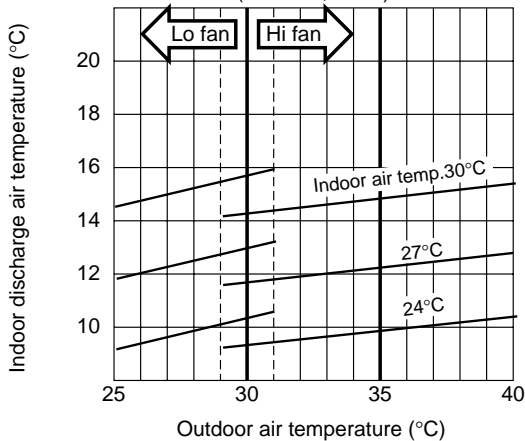

• **Heating Characteristics**

(1) High pressure performance chart
 (RH: 85%, Indoor fan speed: High fan)
 (50/60Hz, 220V)

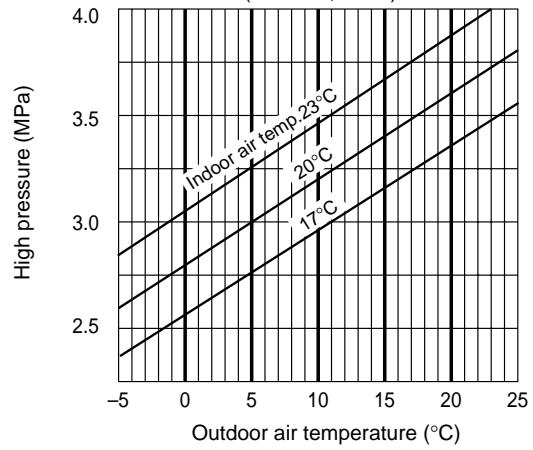

(2) Operating current performance chart
 (RH: 85%, Indoor fan speed: High fan)
 (50/60Hz, 220V)

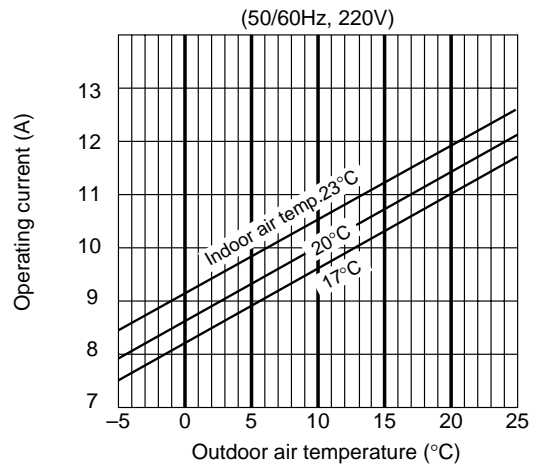

(3) Indoor discharge air performance chart
 (RH: 85%, Indoor fan speed: High fan)
 (50/60Hz, 220V)

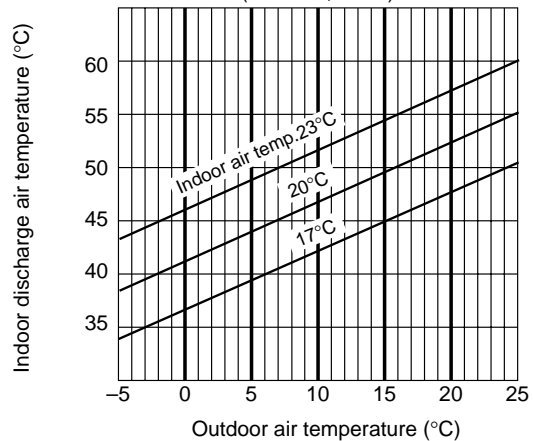

- NOTE**
- This performance chart shows operation of a single wall-mounted indoor unit. The performance chart will vary depending on the indoor unit type.
 - Check each performance value in test-run mode. Electrical performance values represent a combined indoor/outdoor value. (In this case, be sure to stop all the indoor units where performance is not being checked.)
 - The performance is for a tubing length of 7.5 m. If the tubing length is different, the performance chart will vary.

6. ELECTRICAL DATA

6-1. Electric Wiring Diagram

Outdoor Unit AE4MI91AH

Electric Wiring Diagram for 4-room multi outdoor unit (AE4MI91AH)

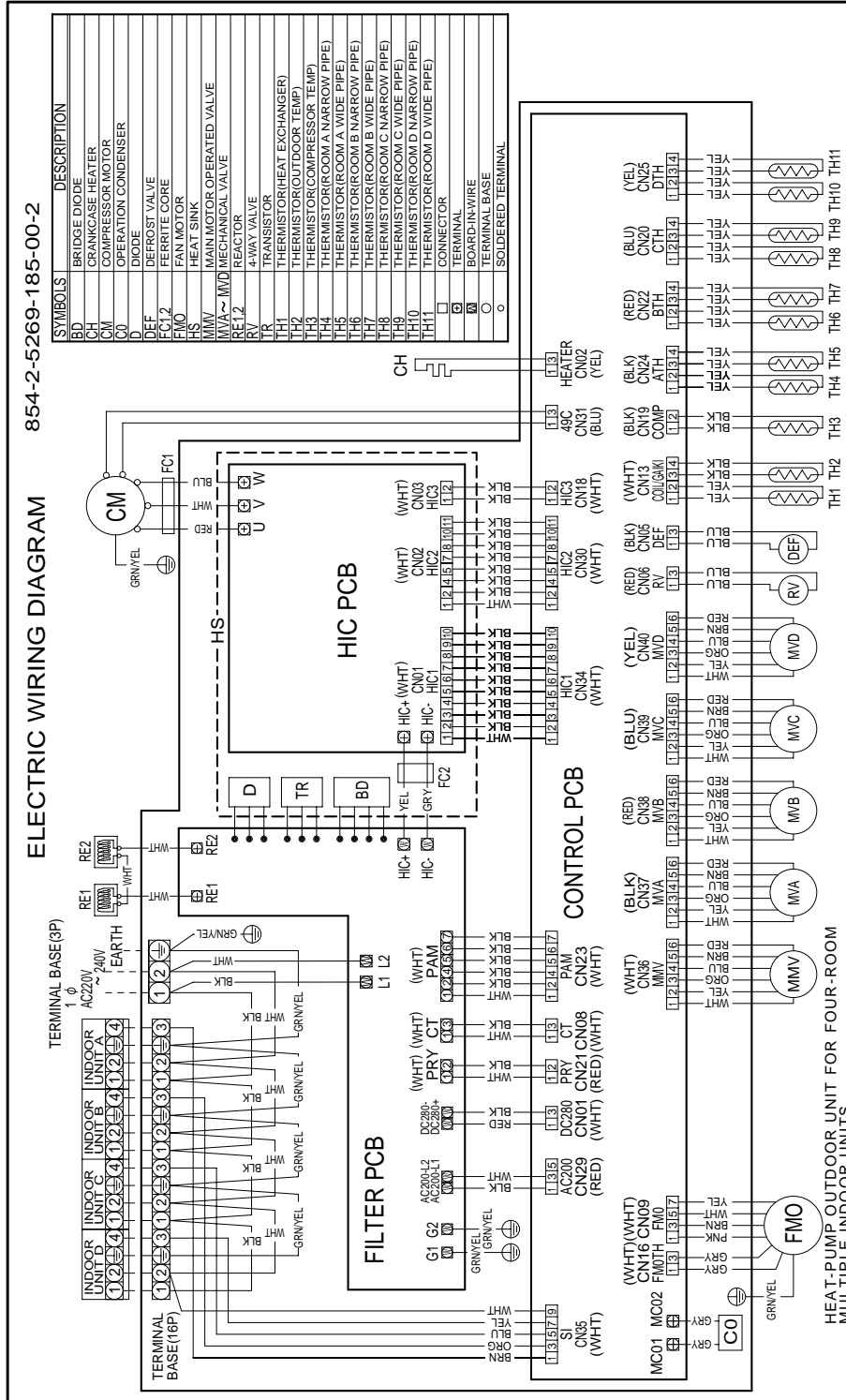

CAUTION

Electric Shock

Before replacing PCBs, turn off the power and check that all lamps on the PCB are off before starting work. Electric shock will occur if work is performed while the lamps are lit.

7. INSTALLATION INSTRUCTIONS

Installation Site Selection

7-1. Indoor Unit



WARNING

To prevent abnormal heat generation and the possibility of fire, do not place obstacles, enclosures and grilles in front of or surrounding the air conditioner in a way that may block air flow.

AVOID:

- direct sunlight.
- nearby heat sources that may affect performance of the unit.
- areas where leakage of flammable gas may be expected.
- places where large amounts of oil mist exist.

DO:

- select an appropriate position from which every corner of the room can be uniformly cooled.
- select a location that will hold the weight of the unit.
- select a location where tubing and drain hose have the shortest run to the outside.
- allow room for operation and maintenance as well as unrestricted air flow around the unit.
- install the unit within the maximum elevation difference (H1, H2, H3, H4) above or below the outdoor unit and within a total tubing length (L1+L2+L3+L4) from the outdoor unit as detailed in Table 1 and Fig. 1.

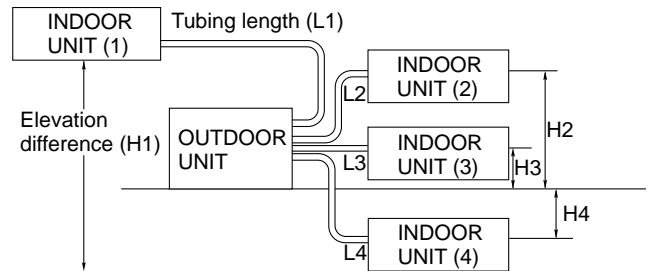

Fig. 1

Table 1

Model	Max. Allowable Tubing Length at Shipment (m)	Limit of Total Tubing Length (m)	Limit of Elevation Difference (H1, H2, H3, H4) (m)
AE4MI91AH	30	70 (L1+L2+L3+L4)	10

NOTE

This outdoor unit requires no refrigerant charge up to the maximum limit for total tubing length of 70 m. Therefore, no refrigerant needs to be added on-site.

In the case below, a joint for connecting tubes of different sizes is needed when connecting the inter-unit tube ($\phi 9.52$) to the outdoor unit valve ($\phi 12.7$).

(1) Connecting indoor unit types 28 to 38 at D

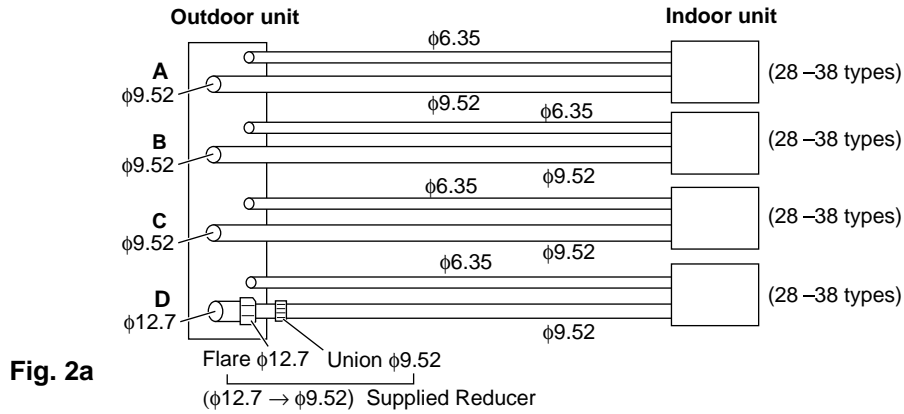

(2) Connecting indoor unit type 50 at D (Length of tube: more than 17 m)

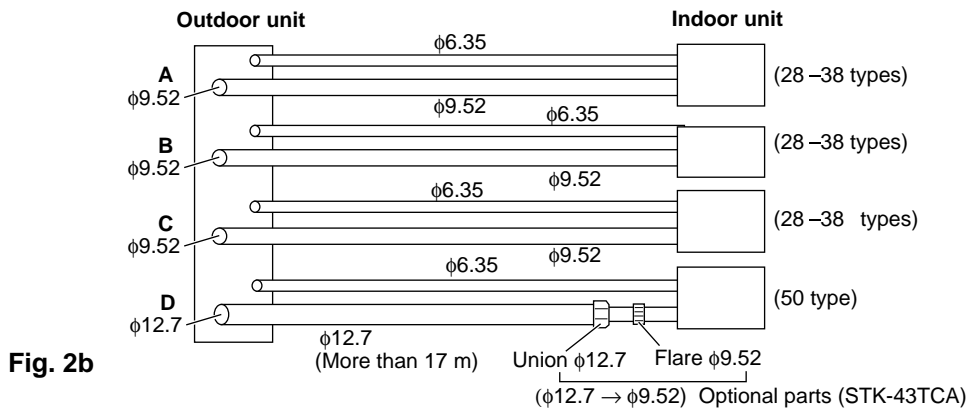

(3) Connecting indoor unit type 50 at D (Length of tube: less than 17 m)

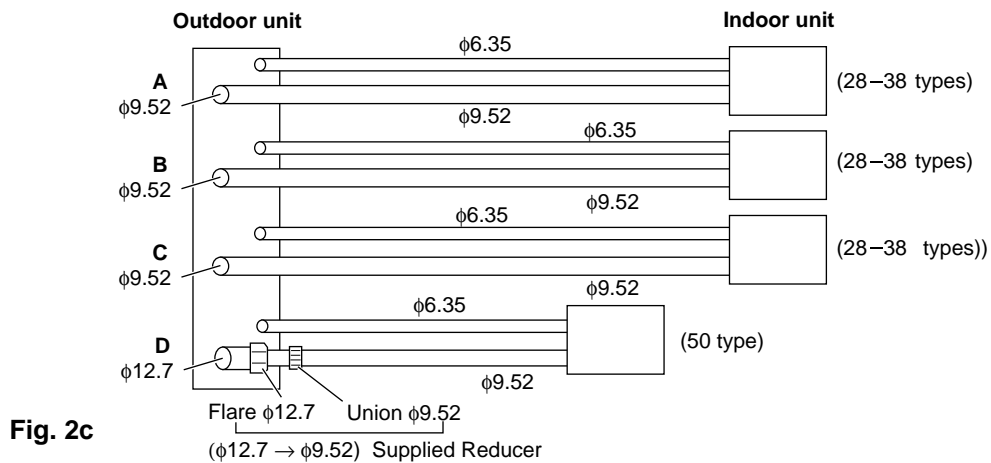

(4) Connecting indoor unit type 70 at D

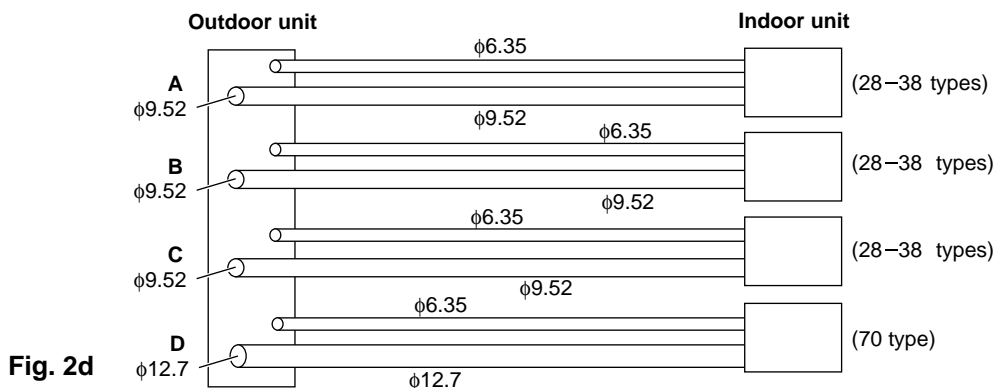

7-2. Outdoor Unit

AVOID:

- heat sources, exhaust fans, etc. (Fig. 3)
- damp, humid or uneven locations.

DO:

- choose a place as cool as possible.
- choose a place that is well ventilated.
- allow enough room around the unit for air intake/exhaust and possible maintenance. (Fig. 4a)
- provide a solid base (level concrete pad, concrete block, 15 × 40 cm beams or equal), a minimum of 15 cm above ground level to reduce humidity and protect the unit against possible water damage and decreased service life. (Fig. 4a)
- install cushion rubber (not provided) under unit's feet to reduce vibration and noise. (Fig. 4b)
- use lug bolts or equal to bolt down unit, reducing vibration and noise.
- select a location where the operating noise and air blowing from the outdoor unit will not disturb neighbors.
- select a location where the clearance indicated by ⇔ in the installation diagram is ensured for the front, rear, left, and right of the main unit.
- install so that the unit is level.
- select a location that can fully support the weight of the outdoor unit, and that will not magnify operating noise or vibration. (Fasten in place with the anchor bolts (M10).)
- provide a base using concrete or similar material, and ensure proper drainage.
- select a location where there is no danger of flammable gas leakage.
- in snowy or rainy regions, be sure to construct a roof to keep off the snow and rain, and inhibit freezing and condensation.
- select a location that is at least 3 meters away from any antennas used for television, radio transceiver, or other equipment.
- for purposes of future service and repair, select a location where the inspection panel can be removed.
- select a location where the drain port will not be obstructed.

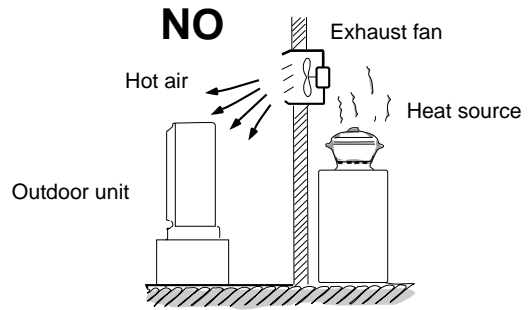

Fig. 3

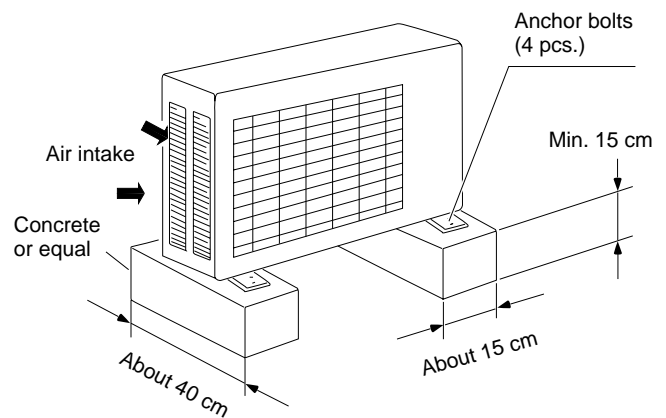
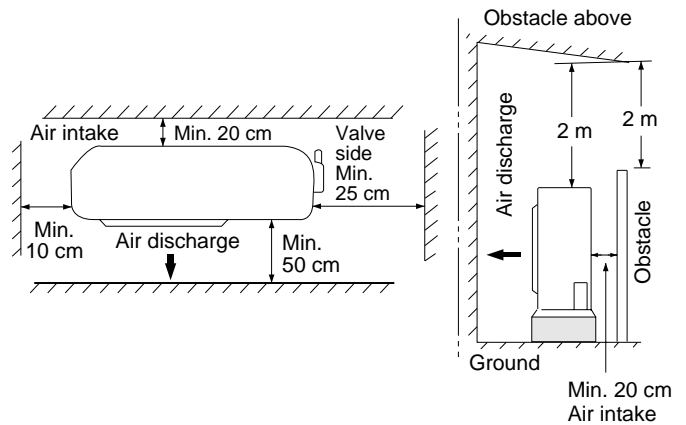

Fig. 4a

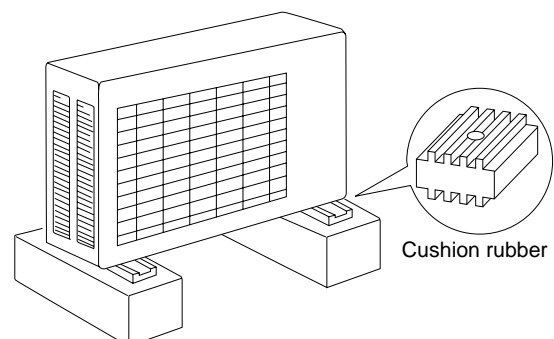

Fig. 4b

Install the inter-unit cable more than 1 meter away from any antenna or power lines or connecting wires used for television, radio, telephone, security system, or intercom. Electrical noise from any of these sources may affect operation.

7-3. Diagram of Outdoor Unit Installation

Never install only a single indoor unit.

Be sure to connect indoor and outdoor units only in combinations that are listed in the catalog or in the combination table that was provided with the outdoor unit. (Use caution. Connecting any other model may result in operation failure and malfunction.)

The dimensions indicated by \Leftrightarrow in the figure below are spaces that are required in order to maintain performance. Install in a location where the dimensions indicated by \Leftrightarrow are ensured, and where 2 or more faces of the unit are unobstructed. In principle, the top direction should be unobstructed.

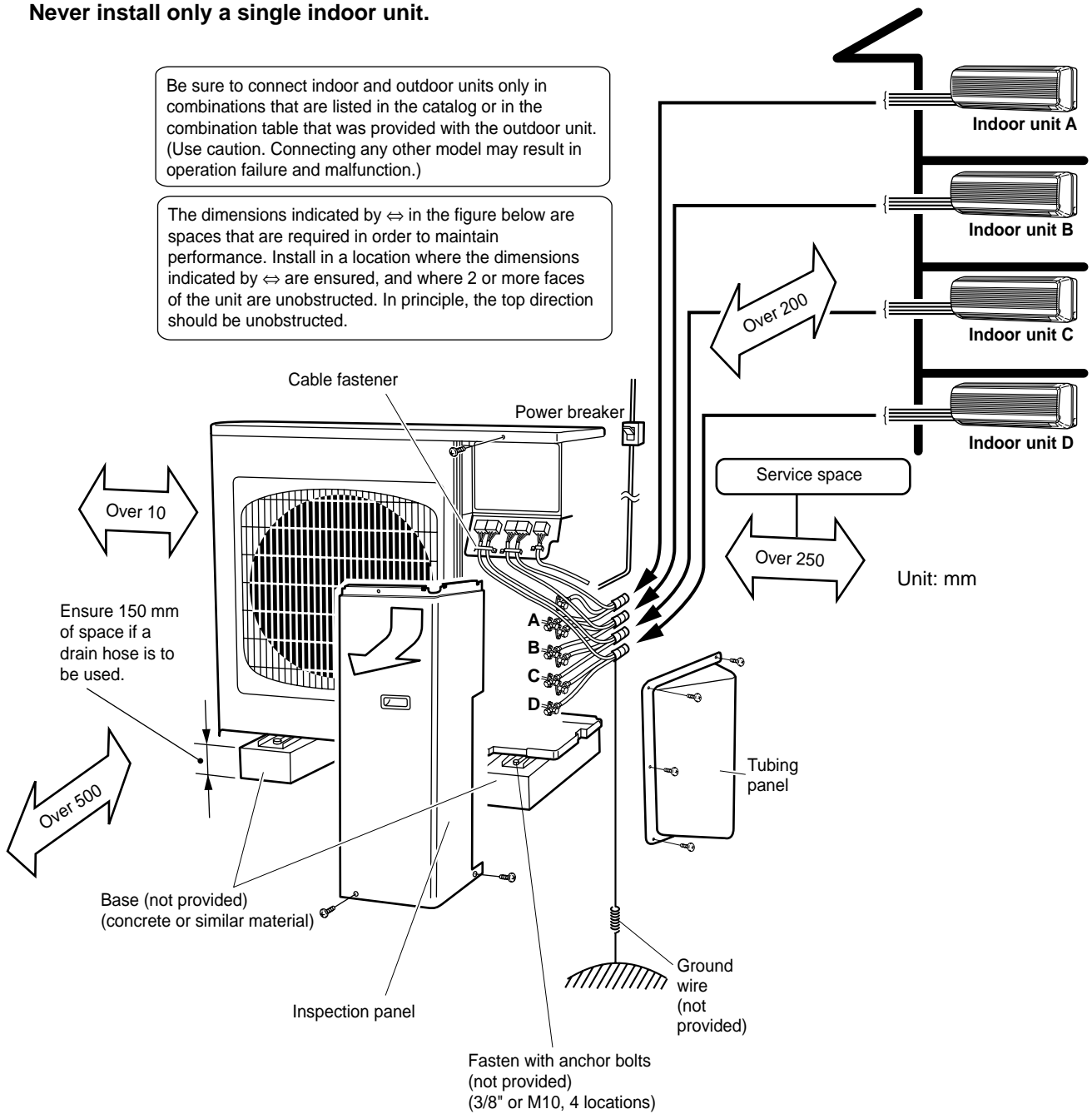

Fig. 5

7-4. Recommended Wire Length and Diameter

Regulations on wiring diameter differ from locality to locality. For field wiring requirements, please refer to your local electrical codes. Carefully observe these regulations when carrying out the installation.

Table 2 shows maximum wire lengths for control line and power line and fuse or circuit capacity.

NOTE

Refer to the wiring system diagram (Fig. 6) for the meaning of "A" and "B" in Table 2.

Table 2

Model	Cross-sectional Area (mm ²)	Max. Power Line Length (B)				Fuse or Circuit Capacity
		1.0	2.0	2.6	3.5	
AE4MI91AH		34 m	15 m	20 m	26 m	30 A



WARNING

- Be sure to comply with local codes on running the wire from the indoor unit to the outdoor unit (size of wire and wiring method, etc.).
- Each wire must be firmly connected.
- No wire should be allowed to touch refrigerant tubing, the compressor, or any moving part.
- Be sure to connect power wires correctly matching up numbers on terminals of the outdoor unit and respective indoor units A – D.



WARNING

To avoid the risk of electric shock, each air conditioner unit must be grounded.



CAUTION

Be sure to connect the power supply line to the outdoor unit as shown in the wiring diagram. The indoor unit draws its power from the outdoor unit.

7-5. Wiring System Diagram

4 indoor units with AE4MI91AH

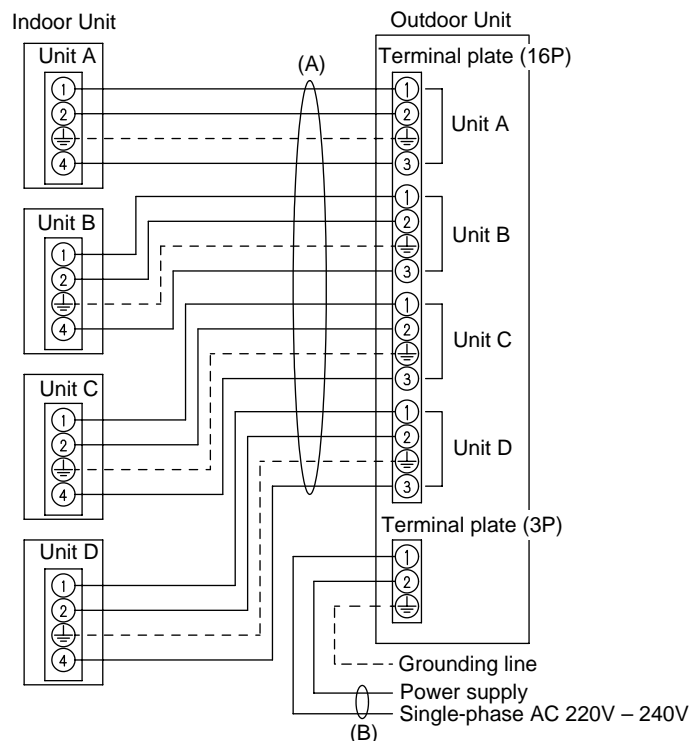
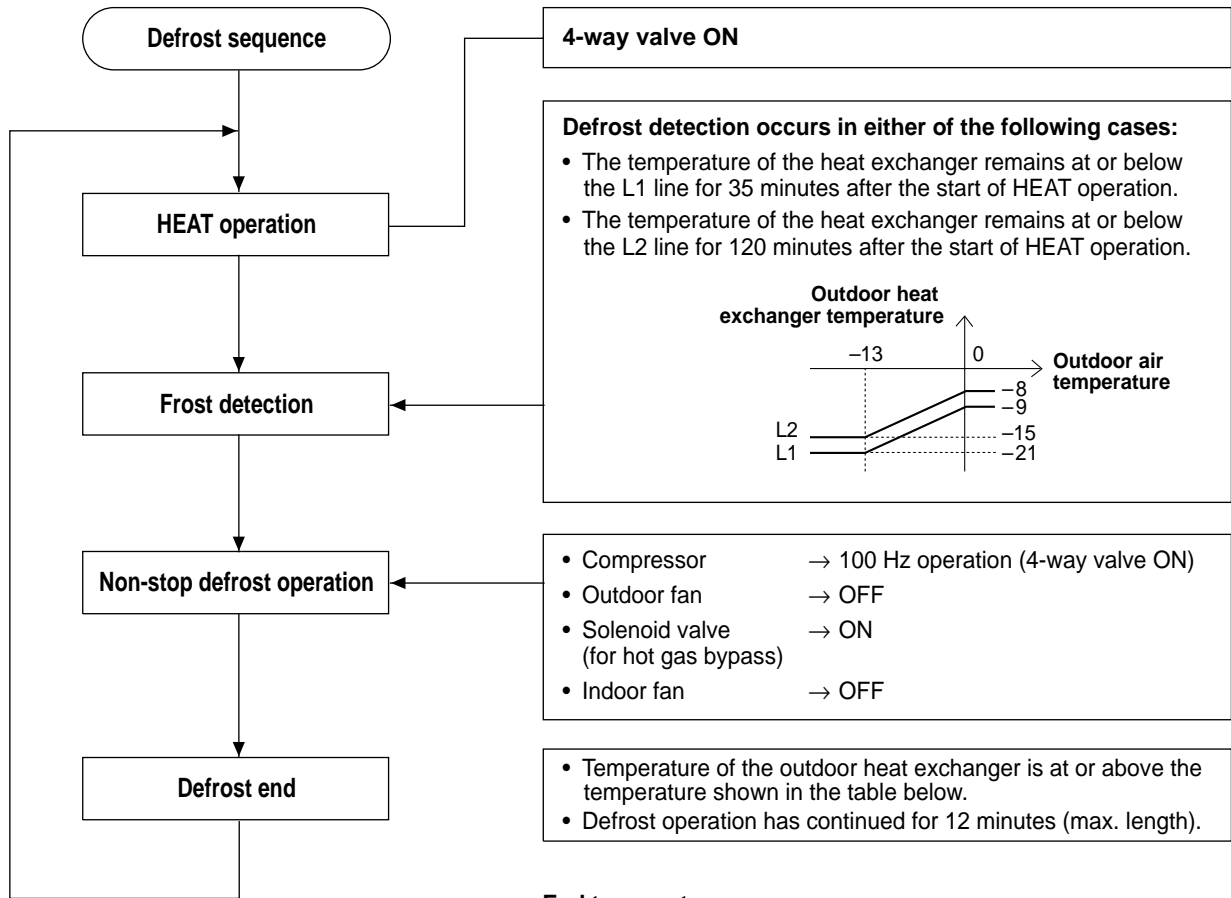

Fig. 6

8. FUNCTIONS

8-1. Defrost Detection and End

8-1-1. Non-stop defrosting



End temperature

Defrost operation time	Less than 2 minutes	2 minutes or more
Coil temperature for ending defrost	Not ended	*1 10°C or higher

*1 The temperature for ending defrost is 7°C or higher when the outdoor air temperature is less than 0°C.

NOTE: • Defrost does not occur during HIGH POWER operation.

If other stopped indoor units are started during defrost operation, they begin operating in defrost mode.

8-1-2. Clean defrost

If all indoor units are stopped during HEAT operation, and frost is detected at the L2 line, and the conditions for defrost are met, then defrost operation occurs, and the unit stops after defrost is completed.

8-2. Current Control

- The operating current may rise as a result of causes including increasing heating or cooling loads or decreases in power voltage. In these cases, the operating frequency is automatically reduced, or operation is stopped, in order to control the operating current so that it is 20 A or less.

As a result:



- Power breakers and fuses will not be tripped.
- Operation can continue during this period with somewhat reduced heating or cooling capacity.
- Operation at normal capacity is restored when the cause of the current rise is eliminated.

Description of function

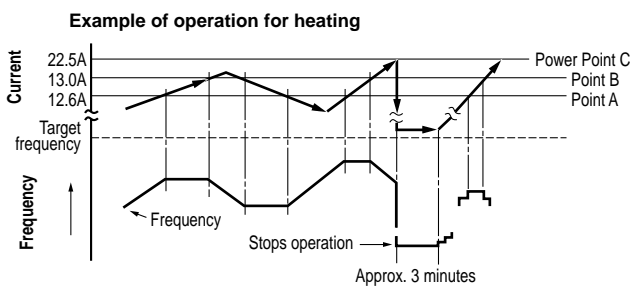

- Operates at the target frequency at Point A and below.
 - Stops increases to the frequency between Points A and B.
 - Reduces the frequency by 1 Hz per 0.5 seconds when Point B is exceeded.
 - Stops operation, and restarts it approximately 3 minutes later, if Point C is exceeded.
- (May operate when sudden voltage fluctuations occur. → Indicates trouble.)

8-2-1. Automatic frequency control

The operating frequency is reduced automatically, or operation is stopped, in order to control the operating current so that it is at or below the values shown in the table below.

	20A	
	HEAT	COOL
Point C (peak cut trip)	22.5	22.5
Point B (Hz reduction)	13.0	14.0
Point A (Hz increase prohibit)	12.6	13.6

NOTE: During defrost operation, the COOL current setting value is used.

8-2-2. Current control

The operating frequency upper limits shown in the figure below are established for frequency reduction and increase-prohibit.

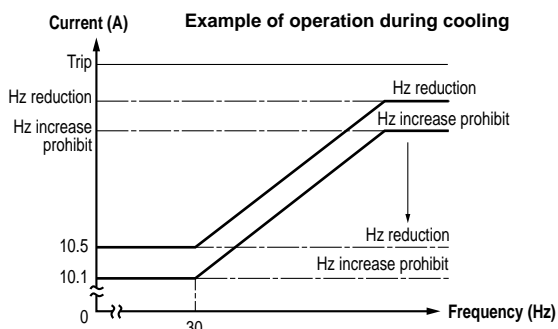

8-3. Low Start Current

Operation starts at 10 Hz, and the start current is less than the normal operating current. This prevents the flickering of fluorescent lights or television screens that occurs when ordinary A/C units start.

8-4. Compressor Temperature Control

To protect the compressor coil from overheating, the operating frequency is controlled based on the compressor discharge temperature.

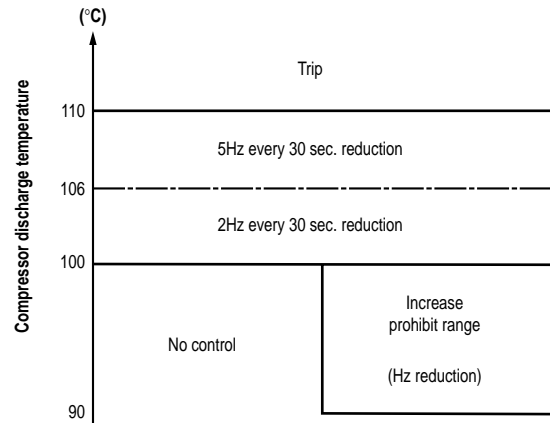

* Within the increase-prohibit range, the range changes to the Hz reduction range (2 Hz every 30 seconds) if the compressor temperature rises by 2°C.

8-5. Outdoor Fan Control

8-5-1. COOL operation

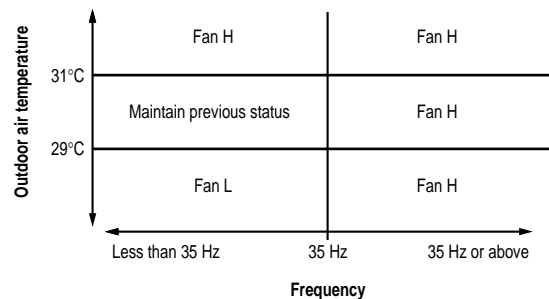

8-5-2. HEAT operation

- (1) The fan speed is changed as shown in the figure below, based on the outdoor air temperature and the operating frequency.

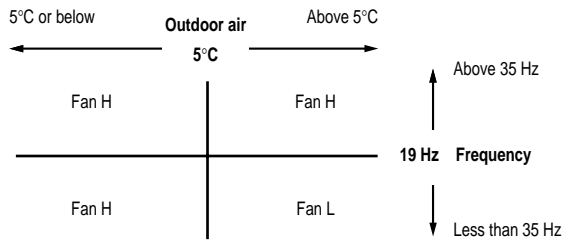

- (2) The fan speed is changed as shown in the figure below based on the highest temperature of the indoor heat exchanger for connected indoor units (including stopped units).

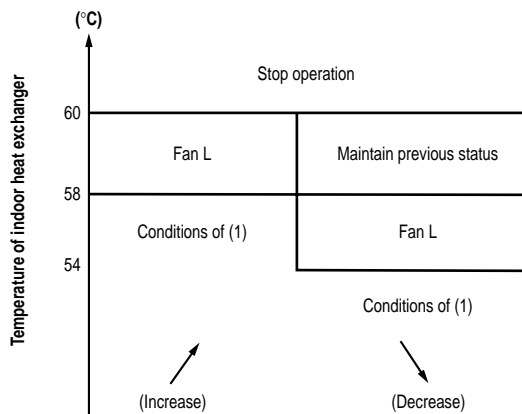

8-6. Control at HEAT Start-up

If HEAT operation is started when the outdoor air temperature is 15°C or below, the unit operates at the HEAT start-up frequency (70 Hz or above).

Reset conditions

- ① The compressor frequency exceeds the start-up frequency of 70 Hz.
- ② The compressor thermostat is OFF.
- ③ Frequency reduction for indoor high-load control has occurred.
- ④ The outdoor air temperature is above 15°C.
- ⑤ The main-unit switch on one or more indoor units is set to TEST run.

9. TROUBLESHOOTING

■ Both the indoor unit and outdoor unit include electronic control circuits. Be sure to pay attention to the following before inspecting or repairing the outdoor-side electronic circuits.

- High-capacity electrolytic capacitors are used inside the outdoor unit controller (inverter). They retain an electrical charge (charging voltage DC 311 V) even after the power is turned OFF, and some time is required for the charge to dissipate.

Be careful not to touch any electrified parts before the control circuit board LED (red) turns OFF.

If the outdoor control circuit board is normal, approximately 60 seconds will be required for the charge to dissipate. However, allow at least 30 minutes for the charge to dissipate if it is thought there might be trouble with the outdoor control circuit board.

(If the outdoor control circuit board fuse has blown, approximately 30 minutes will be required to discharge the high-capacity electrolytic capacitors.)

■ Trouble diagnostics contents

- ① Conditions that do not represent trouble
- ② Outdoor unit trouble diagnostics
- ③ Checking the outdoor unit
- ④ Unit problems and inspection points
Inspection points for each part
- ⑤ Explanation of functions

9-1. Conditions That Do Not Represent Trouble

Inquiry from customer	Explanation
① When the room temperature reaches the desired temperature	When HEAT operation is in progress in other rooms, HEAT operation occurs at a "LL" (very low) fan speed even after the desired room temperature has been reached.

9-2. Outdoor Unit Trouble Diagnostics

If a protective device has activated or there is a sensor failure in the outdoor unit, the 6 error monitor lamps on the outdoor control circuit board will indicate the nature of the trouble.

○ : ON × : OFF

ERR						Error contents
0	1	2	3	4	5	
○	×	×	×	×	×	Compressor discharge temperature sensor
×	×	○	×	×	×	Heat exchanger temperature sensor
○	×	○	×	×	×	Branch tubing A sensor (narrow tubing)
×	○	○	×	×	×	Branch tubing B sensor (narrow tubing)
○	○	○	×	×	×	Branch tubing C sensor (narrow tubing)
×	×	×	○	×	×	Branch tubing D sensor (narrow tubing)
○	○	×	○	×	×	Outdoor air temperature sensor
×	×	○	○	×	×	Branch tubing A sensor (wide tubing)
○	×	○	○	×	×	Branch tubing B sensor (wide tubing)
×	○	○	○	×	×	Branch tubing C sensor (wide tubing)
○	○	○	○	×	×	Branch tubing D sensor (wide tubing)
×	○	×	×	○	×	CT (current) sensor
×	○	○	×	○	×	HIC protective device (current, temperature)

ERR						Error contents
0	1	2	3	4	5	
○	×	○	○	○	×	OTP data failure
×	×	×	○	○	×	Current peak exceeded
○	×	×	○	○	×	Current control failure
○	×	○	×	×	○	Active failure
×	○	×	○	○	×	Compressor discharge temperature high
×	×	○	×	×	○	Zero-cross failure
○	×	×	×	×	○	DC compressor rotation failure
○	○	×	×	○	×	3φ 200 V open phase
×	○	○	×	×	○	Compressor internal thermostat activated
×	×	○	×	○	×	High-pressure switch activated
○	×	○	×	○	×	Miswiring, incorrect tubing connections
○	○	×	×	×	○	Freeze-prevention activated
×	×	○	○	○	×	Reset count exceeded

● Outdoor control circuit board

Error monitor lamps

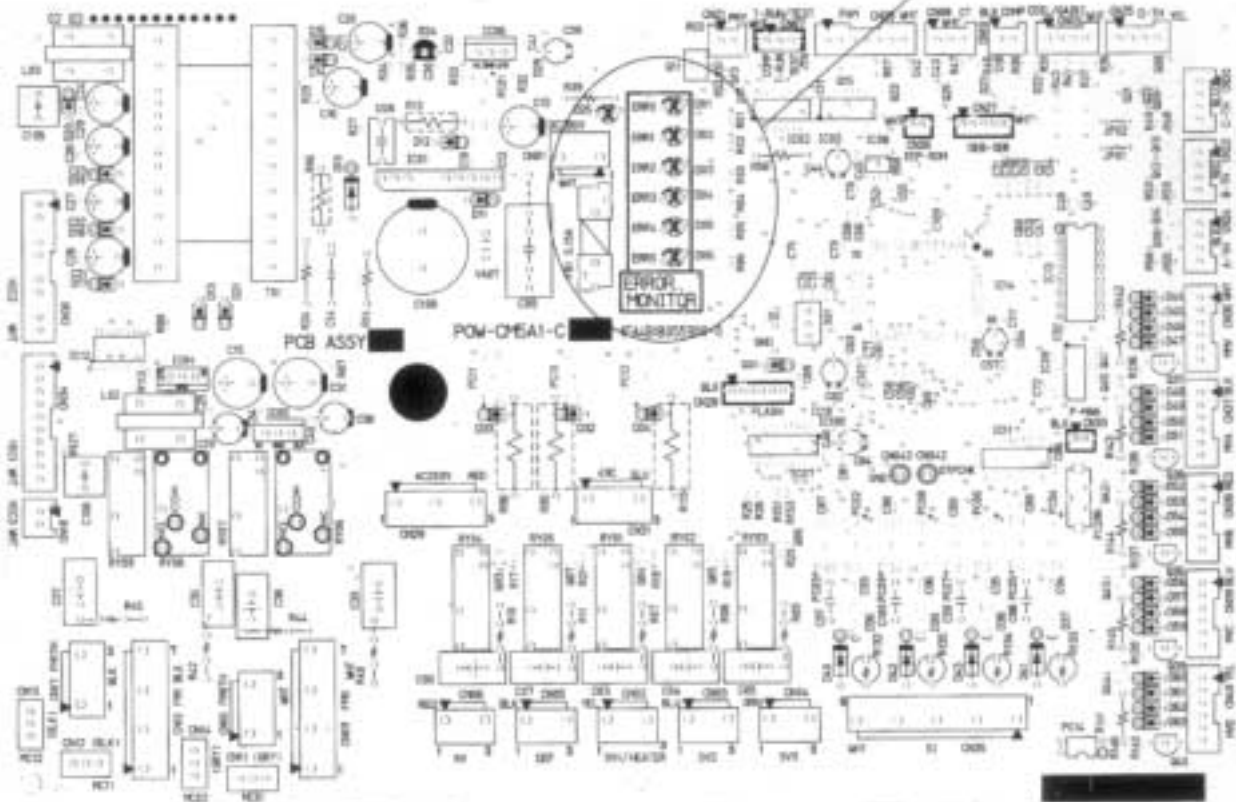

9-3. Checking the Outdoor System

9-3-1. Checking the outdoor unit

No.	Control	Check items (unit operation)
1	<ul style="list-style-type: none"> Apply 220 V AC between terminals 1 and 2 on the outdoor unit 3P terminal block. 	<ul style="list-style-type: none"> The LED (red) on the control circuit board must illuminate.
2	<ul style="list-style-type: none"> Of the connector T-RUN/TEST terminals, short-circuit the T-RUN terminal to the COM terminal. 	<ul style="list-style-type: none"> The compressor, fan motor, 4-way valve, and solenoid valve (for the hot gas bypass) must turn ON. (They turn ON a few seconds after the power is turned ON.)

NOTE: If the above check items are okay, but the outdoor unit does not operate, there may be a faulty connection between the indoor unit and the outdoor unit.

9-3-2. Using forced defrost procedure

No.	Control	Check items (unit operation)
1	<ul style="list-style-type: none"> Connect a dummy resistor of 39 kΩ to the outdoor coil temperature sensor connector. 	<p>■ Non-stop defrost</p> <p>NOTE: The dashed line for the defrost or clean defrost lamp indicates lamp illumination at clean defrost only.</p> <ul style="list-style-type: none"> The maximum length of defrost operation is 12 minutes. <p>Defrost can also be ended based on the below conditions for the outdoor heat exchanger sensor.</p> <p style="padding-left: 40px;">Less than 2 minutes → Not ended 2 minutes or more → 10°C or higher (However, the condition is 7°C or higher when the outdoor air temperature is below 0°C.)</p>

9-4. Unit Problems and Inspection Points

Problems	Indoor unit				Outdoor unit								Others		Note
	Indoor unit does not operate.	Operation lamp flashes.	Operation lamp does not illuminate.	Indoor fan does not turn.	Outdoor unit does not operate.	Outdoor fan does not turn.	4-way valve does not operate.	The compressor (only) does not operate.	The compressor stops on occasion.	The compressor speed does not increase.	The outdoor air temperature is high, however defrost operation occurs.	Defrost operation does not occur.	The electric expansion valve does not operate.	Does not cool or cooling performance is inadequate.	
Self-Diagnostics check		<input type="radio"/>		<input type="radio"/>	<input type="radio"/>						<input type="radio"/>	<input type="radio"/>			
Indoor unit	① Indoor controller (control unit)	<input type="radio"/>	<input type="radio"/>	<input type="radio"/>	<input type="radio"/>										
	② Indoor fan motor				<input type="radio"/>										
	③ Room temperature sensor		<input type="radio"/>												
	④ Heat exchanger temperature sensor		<input type="radio"/>		<input type="radio"/>										
	⑤ Inter-unit cable		<input type="radio"/>			<input type="radio"/>	<input type="radio"/>	<input type="radio"/>	<input type="radio"/>	<input type="radio"/>					
	⑥ Switch circuit board	<input type="radio"/>		<input type="radio"/>											
Outdoor unit	⑦ Outdoor control circuit board		<input type="radio"/>		<input type="radio"/>	<input type="radio"/>	<input type="radio"/>	<input type="radio"/>	<input type="radio"/>	<input type="radio"/>	<input type="radio"/>				
	⑧ Diode module		<input type="radio"/>			<input type="radio"/>									
	⑨ HIC		<input type="radio"/>			<input type="radio"/>									
	⑩ Electrolytic capacitor		<input type="radio"/>			<input type="radio"/>									
	⑪ Fuse		<input type="radio"/>			<input type="radio"/>									
	⑫ Compressor		<input type="radio"/>			<input type="radio"/>	<input type="radio"/>	<input type="radio"/>	<input type="radio"/>	<input type="radio"/>					
	⑬ Compressor protective thermistor		<input type="radio"/>			<input type="radio"/>		<input type="radio"/>	<input type="radio"/>						
	⑭ Outdoor fan motor					<input type="radio"/>			<input type="radio"/>		<input type="radio"/>				
	⑮ 4-way valve						<input type="radio"/>								
	⑯ Coil thermistor		<input type="radio"/>								<input type="radio"/>	<input type="radio"/>			
	⑰ Electric expansion valve												<input type="radio"/>	<input type="radio"/>	<input type="radio"/>
	⑱ Branch tubing temperature sensor		<input type="radio"/>												
Others	⑲ Breaker	<input type="radio"/>			<input type="radio"/>										
	⑳ Refrigerant gas pressure							<input type="radio"/>					<input type="radio"/>	<input type="radio"/>	Measure during a test run.

- For details about the inspection points, refer to Inspection points for each part.

9-4-1. Outdoor control circuit board

Refer to 9-3-1. Checking the outdoor unit.

NOTE: Do not remove or insert the outdoor control circuit board connector when power is being supplied to it. (The controller will be damaged.)

9-4-2. HIC

		HIC measurement points			
		+	+	-	-
Tester polarity	⊕ (Black)	+	U	-	U
			V		V
			W		W
	⊖ (Red)	-	-	+	+
		U		U	
		V		V	
	W		W		
Continuity		∞	∞	Below 1kΩ	Below 1kΩ

Perform the continuity tests shown in the table above. Locations which are not as shown in the table have suffered HIC failures.

NOTE: Ordinarily, the red lead of the tester has negative polarity. However, the reverse may be true, particularly with digital testers. Use caution.

9-4-3. Fuse

Check the continuity visually or with a tester.

9-4-4. Compressor

Check for an open circuit in the compressor coil winding.

9-4-5. Compressor protective sensor (compressor discharge temperature thermistor)

Check that the sensor is securely contained in the thermostat holder.

9-4-6. Outdoor fan motor

Turn the fan slowly by hand.

- If the fan rotates easily:
 - Ⓐ Replace the running capacitor on the outdoor control circuit board.
 - Ⓑ Check for an open circuit in the fan motor coil winding.
 - Ⓒ Use the tester AC range to check whether voltage is reaching the connector on the outdoor fan motor circuit board. If the needle moves, the result is normal.
- If the fan does not rotate easily:
 - Ⓐ Check whether something is obstructing the fan, or if the fan itself is coming into contact with the outer case, preventing it from rotating. Correct if necessary.
 - Ⓑ Otherwise, the fan motor bearings have seized. Replace the bearings.

9-4-7. 4-way valve

Of the outdoor control circuit board connector T-RUN/TEST terminals, short-circuit the T-RUN terminal to the COM terminal. Perform a test run of the unit alone, and check whether the 4-way valve inside the outdoor unit produces a click sound.

9-4-8. Coil thermistor

Check that the sensor is securely contained in the thermostat holder.

9-4-9. Electric expansion valve

- When replacing the electric expansion valve and coil, be sure to attach the connectors in the correct positions. Labels are applied to the valve body and coil, corresponding to the connector colors, to identify them.

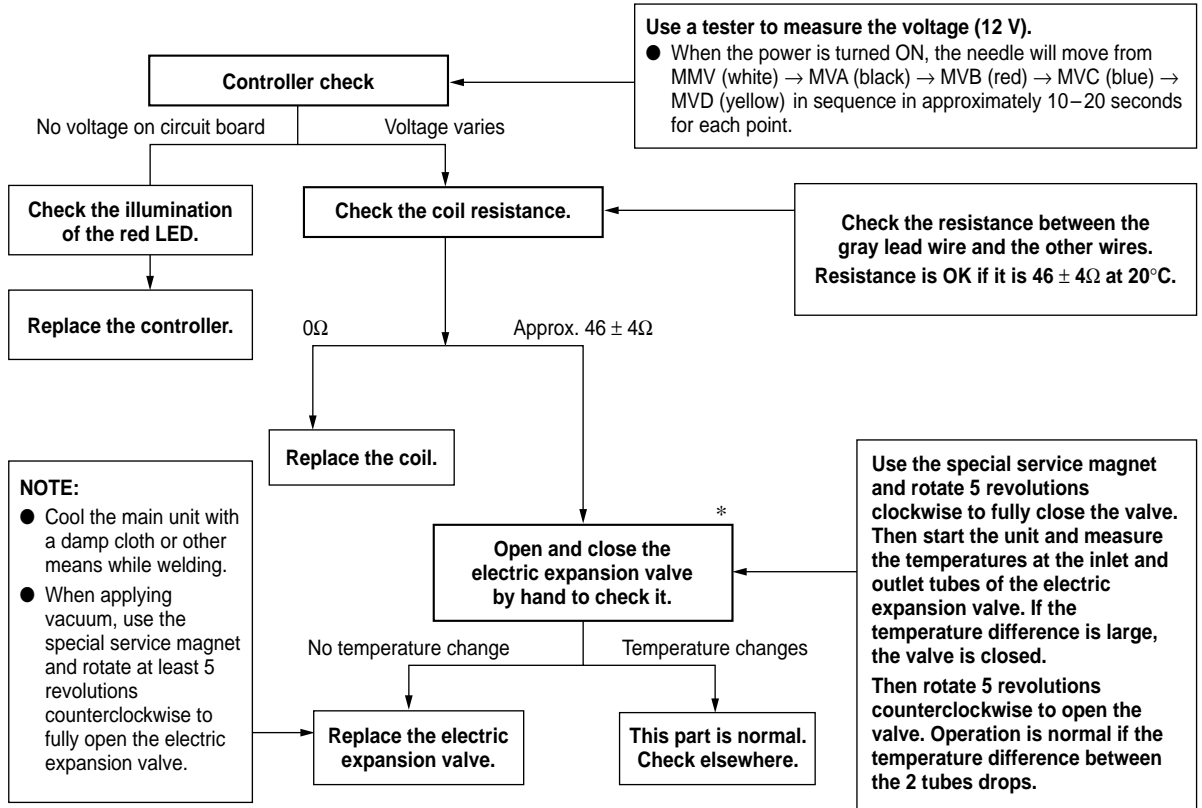

* If you have manually checked the electric expansion valve, be sure to reapply the outdoor 220 V after you have replaced the wiring. (The position of the electric expansion valve will be changed.)

9-4-10. Branch tubing temperature sensor

Check that the sensor is securely contained in the thermostat holder.

9-4-11. Breaker

Check whether or not the breaker has been tripped.

- Check that the breakers and fuses used are of the specified capacity.
- Check that the breaker and its line are exclusive for A/C use.

9-4-12. Refrigerant gas pressure

Start a COOL test run, and measure the temperatures of the A/C intake air and discharge air. Compare the values with the performance charts.

- If the values are higher than the performance charts:
Check for refrigerant shortage or blockage of the refrigerant circuit.

Assessment of refrigerant shortage:

- The low-pressure pressure value is 5 MPa or more below the value in the performance charts.
- There is little condensation on the indoor heat exchanger, which overall appears dry.

Distinguishing between refrigerant shortage and refrigerant circuit blockage:

If the low-pressure pressure does not change when the circuit is charged 2–3 times with refrigerant gas (200 g each time), or if the change is small, then the problem may not be refrigerant shortage. The problem may be a blockage of the refrigerant circuit.

- Check that there is no internal leakage inside the 4-way valve:
At the low-pressure side tubing, check that there is no temperature difference between the intake and discharge of the 4-way valve.
- Check that the electric expansion valve is not blocked. Check as described on the preceding page.

9-5. Explanation of Functions

	Control/conditions	Unit operation	Explanation
INITIAL	Breaker is ON.		Power is supplied to the indoor and outdoor unit control circuits, however the unit remains stopped. Positioning of the outdoor unit electric expansion valve is performed.
	The ON/OFF operation button on the remote controller is pressed.	If automatic operation mode has been selected with the remote controller, operation begins in HEAT, SENSOR DRY, or COOL mode depending on the room temperature and outdoor temperature at the time operation starts.	<ul style="list-style-type: none"> ● This applies in the case of automatic HEAT/COOL operation.
		 Depending on the operational mode, refer to the HEAT, SENSOR DRY, or COOL item.	
HEAT	The ON/OFF operation button on the remote controller is pressed.	<ul style="list-style-type: none"> ● Operation lamp illuminates. ● Indoor fan operates at "LL" (very low) or stopped to prevent cold air from being emitted. ● Outdoor unit begins operating after forced-stop is canceled. 	<ul style="list-style-type: none"> ● The unit is forced to stop for 3 minutes after the power is turned ON, or 3 minutes after the compressor stops, in order to protect the compressor. The frequency is increased at the rate of 1 Hz every 0.5 seconds.
		<ul style="list-style-type: none"> ● When the indoor coil temperature rises, <ul style="list-style-type: none"> – the compressor starts, – the outdoor fan starts, – and the indoor fan changes from "LL" to the set fan speed. 	<ul style="list-style-type: none"> ● Depending on the relationship between the remote controller temperature setting and the room temperature, the compressor may stop temporarily (in other words, the thermostat may turn OFF).
		When the frequency reaches α Hz, frequency increases are stopped for a period of β seconds. (Refer to Table 2 on page 28.)	This is in order to stabilize the return of oil to the compressor.
		The frequency then increases.	If the indoor and outdoor temperatures are high, the current peak cut-off activates, stopping any increases in frequency.
	The room temperature has reached the desired temperature.	<ul style="list-style-type: none"> ● The indoor temperature and the remote controller temperature setting are approximately equal. 	Operating frequency is stabilized in order to maintain a comfortable environment.
	The thermostat turns OFF.	<ul style="list-style-type: none"> ● The indoor fan speed switches to "LL" (very low). 	<ul style="list-style-type: none"> ● The outdoor unit stops. (It does not stop if the thermostat for another indoor unit is ON.) ● Approximately 30 seconds after the thermostat turns OFF, the indoor fan speed switches to "LL."
	The indoor and outdoor temperatures are high.	In order to protect the compressor, the outdoor unit will not operate for 3 minutes after the thermostat turns OFF, even if the room temperature drops below the desired temperature.	<ul style="list-style-type: none"> ● The outdoor unit starts automatically after 3 minutes. ● During these 3 minutes, a low-pressure pressure balance is achieved, allowing the compressor to start more easily.
		<ul style="list-style-type: none"> ● The frequency is not increased, even if there is a difference between the room temperature and the desired temperature. In some cases, the frequency may be decreased. 	<ul style="list-style-type: none"> ● The amount of heat pump exceeds the amount of heat radiation from the room. Therefore, there is no need to further increase the compressor capacity, and the frequency is stabilized or lowered.
The thermostat turns ON.	<ul style="list-style-type: none"> ● The indoor unit fan speed changes from "LL" to set the fan speed. 	The unit operated before, and the temperature of the indoor heat exchanger is relatively warm. Therefore, the fan speed may start at the set fan speed at the same time that the thermostat turns ON.	

	Control/conditions	Unit operation	Explanation
HEAT	When defrost operation begins, frost has formed on the outdoor unit (when the ambient air temperature is low).	Non-stop defrost <ul style="list-style-type: none"> ● Indoor fan: Intermittent operation ● Outdoor fan: Stopped ● Compressor: 120 Hz ● Solenoid valve (for hot gas bypass): ON ● 4-way valve: Remains ON. ● Defrost lamp: Remains OFF. (Lamp is ON for clean defrost.) 	Defrost operation begins based on outdoor temperature conditions. Non-stop defrost (Refer to Fig. 1 below.) ① After HEAT operation begins, the temperature of the outdoor heat exchanger is at or below the L1 line for 35 minutes. ② After HEAT operation begins, the temperature of the outdoor heat exchanger is at or below the L2 line for 120 minutes.
			The 4-way valve remains ON during defrost.
			<ul style="list-style-type: none"> ● The outdoor fan stops and the solenoid valve turns ON, allowing the refrigerant to bypass the indoor unit.
			<ul style="list-style-type: none"> ● The operating frequency during defrost is 120 Hz. (Frequency is lowered if the current peak cut-off function is activated.)
			<ul style="list-style-type: none"> ● The maximum length of a single defrost operation is 12 minutes. ● For the outdoor heat exchanger temperature conditions for ending defrost, refer to Table 1 below.
	Defrost end	<ul style="list-style-type: none"> ● Indoor fan turns ON. ● After 10 seconds, the solenoid valve (for hot gas bypass) turns OFF. <p style="text-align: center;">↓</p> <ul style="list-style-type: none"> ● When the cold air feel has disappeared, the indoor fan starts and gradually increases speed until it reaches the set speed. 	_____
	STOP [Clean defrost] Defrost is performed when the outdoor unit is stopped, and the temperature of the outdoor unit coil is at or below the L2 line. (Refer to Fig. 1 below.)	All indicator lamps turn OFF. The indoor and outdoor units stop.	_____
	Operation is restarted within 4 hours (only when AUTO mode is selected with the remote controller).	Starts operating in the same operating mode (HEAT) and with the same temperature settings as before operation was stopped.	Within 4 hours after operation was stopped, it is assumed that there has been no significant change in the indoor and outdoor temperatures, and the previous conditions (HEAT) are stored.
	Operation starts after 4 hours or more have passed.	New operation begins based on the temperature conditions at the time the ON/OFF button is pressed.	_____

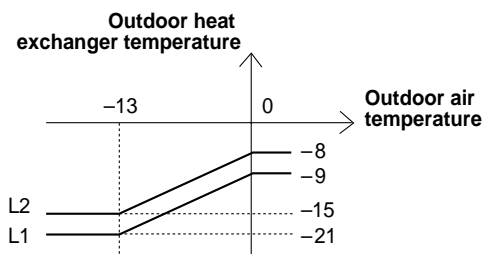

Fig. 1

End temperature

Defrost operation time	Less than 2 minutes	2 minutes or more
Coil temperature for ending defrost	Not ended	*1 10°C or higher

*1 The temperature for ending defrost is 7°C or higher when the outdoor air temperature is less than 0°C.

Table 1

	Control/conditions	Unit operation	Explanation
COOL	The ON/OFF operation button on the remote controller is pressed.	<ul style="list-style-type: none"> ● The operation lamp illuminates. ● The indoor fan operates at the set fan speed. ● The outdoor unit stops. 	The outdoor unit does not operate for 3 minutes even after the breaker is turned ON.
		The outdoor unit starts. (Compressor and the outdoor fan start.)	<ul style="list-style-type: none"> ● The frequency is increased at the rate of 1 Hz every 0.5 seconds.
		When the frequency reaches α Hz, frequency increases are stopped for a period of β seconds. (Refer to Table 2 below.)	This is in order to stabilize the return of oil to the compressor.
		The frequency then increases.	If the indoor and outdoor temperatures are high, the current peak cut-off activates, stopping any increases in frequency.
	The room temperature has reached the desired temperature.	The indoor temperature and the desired temperature are approximately equal.	Operating frequency is stabilized in order to maintain a comfortable environment.
	The thermostat turns OFF.	_____	The outdoor unit stops. (It does not stop if the thermostat for another indoor unit is ON.)
	The thermostat turns ON again.	After the thermostat turns ON again, the outdoor unit will not operate for 3 minutes, even if the room temperature increases above the desired temperature.	After 3 minutes, the outdoor unit begins operating automatically. During these 3 minutes, a pressure balance is achieved, allowing the compressor to start more easily.
	Freeze prevention	<ul style="list-style-type: none"> ● When the temperature of the indoor heat exchanger drops to approximately 2°C or below, the compressor turns OFF, the outdoor fan turns OFF, and the indoor fan continues operating with no changes. <p style="text-align: center;">↓</p> <ul style="list-style-type: none"> ● Approximately 3 minutes later, if the temperature of the indoor heat exchanger is above 8°C, the system returns to its original conditions. 	In order to protect against freezing, the compressor stops temporarily, until the temperature of the indoor heat exchanger has risen.
Stop	All indicator lamps turn OFF. The indoor and outdoor units stop.	_____	
Operation is restarted within 4 hours (only when AUTO mode is selected with the remote controller).	Starts operating in the same operating mode (COOL) and with the same temperature settings as before operation was stopped.	Within 4 hours after operation was stopped, it is assumed that there has been no significant change in the indoor and outdoor temperatures, and the previous conditions (COOL) are stored.	
Operation starts after 4 hours or more have passed.	New operating mode is determined based on the temperature conditions at the time the ON/OFF operation button is pressed.	_____	

Frequency control

α (Hz)	β (seconds)	
	Outdoor air temperature is below 0°C.	Outdoor air temperature is 0°C or higher.
25 Hz	120 seconds	60 seconds
35 Hz	60 seconds	30 seconds
45 Hz	60 seconds	30 seconds
55 Hz	18 seconds	90 seconds

Table 2

(1/f fluctuation fan)

	Control/conditions	Unit operation	Explanation
SENSOR DRY	The ON/OFF operation button on the remote controller is pressed.	<ul style="list-style-type: none"> The operation lamp illuminates. The indoor fan operates at the set fan speed. The outdoor unit stops. 	The outdoor unit does not operate for 3 minutes even after the breaker is turned ON.
		The outdoor unit starts. (Compressor and the outdoor fan start.)	<ul style="list-style-type: none"> The frequency is increased at the rate of 1 Hz every 0.5 seconds.
		When the frequency reaches α Hz, frequency increases are stopped for a period of β seconds. (Refer to Table 2.)	This is in order to stabilize the return of oil to the compressor.
		The frequency then increases.	If the indoor and outdoor temperatures are high, the current peak cut-off activates, stopping any increases in frequency.
	The room temperature reaches the desired temperature, and there is no need for further cooling.	<ul style="list-style-type: none"> DRY operation starts. <p>DRY A operation</p> <ul style="list-style-type: none"> The indoor fan changes between "Low" and "LL" (very low) over a 6-minute cycle. This is 1/f fluctuation fan operation. (Refer to Fig. 2 below.) 	<p>Operating frequency is stabilized in order to maintain a comfortable environment.</p> <ul style="list-style-type: none"> Operates to effectively dehumidify the air while not excessively reducing the indoor temperature. The indoor unit operates at 1/f fluctuation fan operation, at a fan speed that does not cause a chilly feeling.
	The room temperature is 15°C or higher, and is slightly too cold.	<p>DRY B operation</p> <ul style="list-style-type: none"> The indoor fan changes between "Low" and "LL" (very low) over a 6-minute cycle. This is 1/f fluctuation fan operation. →① <p style="text-align: center;">↓</p> <ul style="list-style-type: none"> After approximately 3 minutes, the compressor turns OFF, the outdoor fan turns OFF, and the indoor fan turns OFF. <p style="text-align: center;">↓</p> <ul style="list-style-type: none"> After approximately 6 minutes, the conditions return to those in →①. 	The compressor operates on a 3-minutes ON, 6-minutes OFF cycle, to prevent the room temperature from dropping too much.
	The room temperature is below 15°C.	<ul style="list-style-type: none"> Monitoring operation begins. 	When monitoring operation begins, the compressor stops, and the indoor fan operates at "LL" (very low) speed.

● 1/f fluctuation fan (AWMI....AHL)

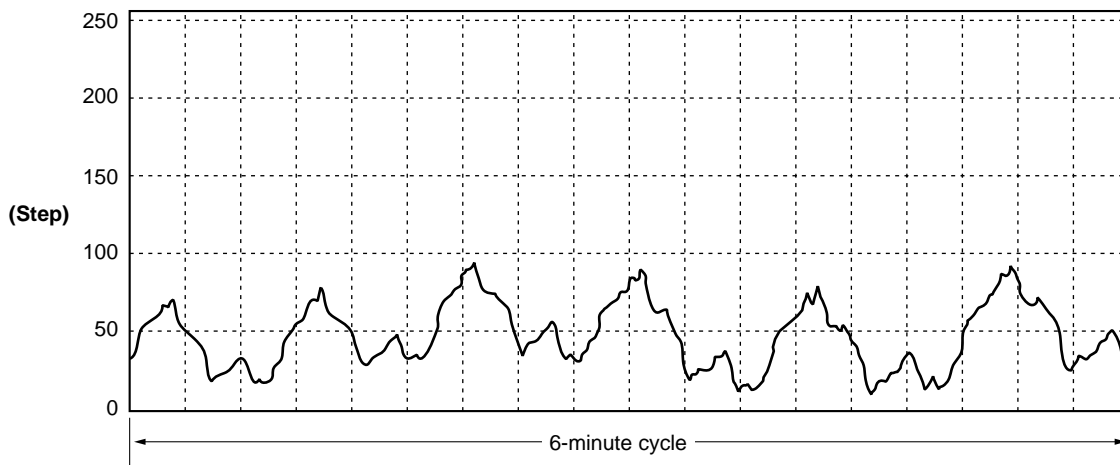

Fig. 2

10. REFRIGERANT R410A: SPECIAL PRECAUTIONS WHEN SERVICING UNIT

10-1. Characteristics of New Refrigerant R410A

10-1-1. What is New Refrigerant R410A?

R410A is a new refrigerant that contains two types of pseudo-non-azeotropic refrigerant mixture. Its refrigeration capacity and energy efficiency are about the same level as the conventional refrigerant, R22.

10-1-2. Components (mixing proportions)

HFC32 (50%) / HFC125 (50%)

10-1-3. Characteristics

- Less toxic, more chemically stable refrigerant
- The composition of refrigerant R410A changes whether it is in a gaseous phase or liquid phase. Thus, when there is a refrigerant leak the basic performance of the air conditioner may be degraded because of a change in composition of the remaining refrigerant. **Therefore, do not add new refrigerant.** Instead, recover the remaining refrigerant with the refrigerant recovery unit. Then, after evacuation, totally recharge the specified amount of refrigerant with the new refrigerant at its normal mixed composition state (in liquid phase).
- When refrigerant R410A is used, the composition will differ depending on whether it is in gaseous or liquid phase, and the basic performance of the air conditioner will be degraded if it is charged while the refrigerant is in gaseous state. **Thus, always charge the refrigerant while it is in liquid phase.**



CAUTION

Ether-type oil is used for compressor oil for R410A-type units, which is different from the mineral oil used for R22. Thus more attention to moisture prevention and faster replacement work compared with conventional models are required.

10-2. Checklist Before Servicing

Use a clutch-type flare tool for R410A or the conventional flare tool. Note that sizes of the resultant flares differ between these two tools. Where a conventional flare tool is used, make sure to observe A Specification (amount of extrusion) by using the flare spacer.

Diameter of tube (ϕ D)	A Specification	
	Flare tool for R410A	Conventional flare tool (for R22)
$\phi 6.35$ (1/4")	0 – 0.5 mm	1.0 – 1.5 mm
$\phi 9.52$ (3/8")	0 – 0.5 mm	1.0 – 1.5 mm
$\phi 12.7$ (1/2")	0 – 0.5 mm	1.0 – 1.5 mm

• Size of flare

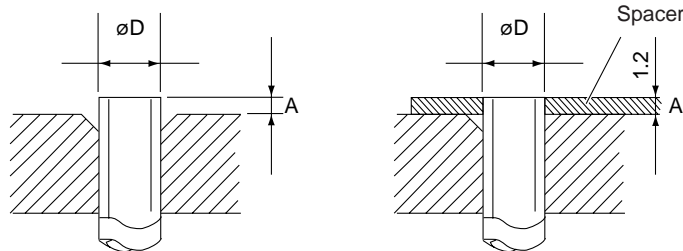

Flare tool for R410A

Conventional flare tool (R22)

- **Tubing precautions**

Refrigerant R410A is more easily affected by dust or moisture compared with R22, thus be sure to temporarily cover the ends of the tubing with caps or tape prior to installation.

Never use 0.7mm-thick copper tubing or tubing which is less than 0.8mm in thickness, since air conditioners with R410A are subject to higher pressure than those using R22 and R407C.

- **No addition of compressor oil for R410A**

No additional charge of compressor oil is permitted.

- **No use of refrigerant other than R410A**

Never use a refrigerant other than R410A.

- **If refrigerant R410A is exposed to fire**

Through welding, etc., toxic gas may be released when R410A refrigerant is exposed to fire. Therefore, be sure to provide ample ventilation during installation work.

- **Caution in case of R410A leak**

Check for possible leak points with the special leak detector for R410A. If a leak occurs inside the room, immediately provide thorough ventilation.

10-3. Tools Specifically for R410A

- For servicing, use the following tools for R410A

Tool Distinction	Tool Name
Tools specifically for R410A	<ul style="list-style-type: none"> ● Gauge manifold ● Charging hose ● Gas leak detector ● Refrigerant cylinder ● Charging cylinder ● Refrigerant recovery unit ● Vacuum pump with anti-reverse flow (*1) (Solenoid valve-installed type, which prevents oil from flowing back into the unit when the power is off, is recommended.) ● Vacuum pump (*2) ... can be used if the following adapter is attached. ● Vacuum pump adapter (reverse-flow prevention adapter) (*3). (Solenoid valve-installed adapter attached to a conventional vacuum pump.) ● Electronic scale for charging refrigerant ● Flare tool
Tools which can be commonly used for R22, R407C, and R410A	<ul style="list-style-type: none"> ● Bender ● Torque wrench ● Cutter, reamer ● Welding machine, nitrogen gas cylinder



CAUTION

- The above tools specifically for R410A must not be used for R22 and R407C. Doing so will cause malfunction of the unit.
- For the above vacuum pump (*1, *2) and vacuum pump adapter (*3), those for R22-type units can be used for R407C-type. However, they must be used exclusively for R410A and never alternately with R22 and R407C.
- To prevent other refrigerants (R22, R407C) from being mistakenly charged to this unit, sizes of the service ports and flare nuts of the narrow tube service valve and wide tube service valve have been altered.

10-4. Tubing Installation Procedures

When the tubes are connected, ***always apply HAB oil on the flare portions to improve the sealing of tubing.***

The following is the **HAB oil** generally used:

Esso: ZERICE S32

NOTE

For details on tubing installation procedures, refer to the installation manuals attached to the indoor unit and outdoor unit.

10-5. In Case of Compressor Malfunction



CAUTION

- Should the compressor malfunction, be sure to make the switch to a replacement compressor as quickly as possible.
- Use only the tools indicated exclusively for R410A. → See “10-3. Tools Specifically for R410A.”

10-5-1. Procedure for replacing compressor

(1) Recovering refrigerant

- Any remaining refrigerant inside the unit should not be released to the atmosphere, but recovered using the refrigerant recovery unit for R410A.
- Do not reuse the recovered refrigerant, since it will contain impurities.

(2) Replacing Compressor

- Soon after removing seals of both discharge and suction tubes of the new compressor, replace it quickly.

(3) Checking for sealing

- Use nitrogen gas for the pressurized gas, and never use a refrigerant other than R410A. Also do not use oxygen or any flammable gas.

(4) Evacuation

- **Use a solenoid valve-installed vacuum pump** so that even if power is cut off in the middle of evacuation of air due to a power interruption, the valve will prevent the pump oil from flowing back.
- The equipment may be damaged if moisture remains in the tubing, thus carry out the evacuation thoroughly.
- When using a vacuum pump with exhaust air volume more than 25L/min. and ultimate vacuum pressure rate of 0.05Torr:

Standard time for evacuation

Length of tubing	Less than 10 meters	More than 10 meters
Time	More than 10 minutes	More than 15 minutes

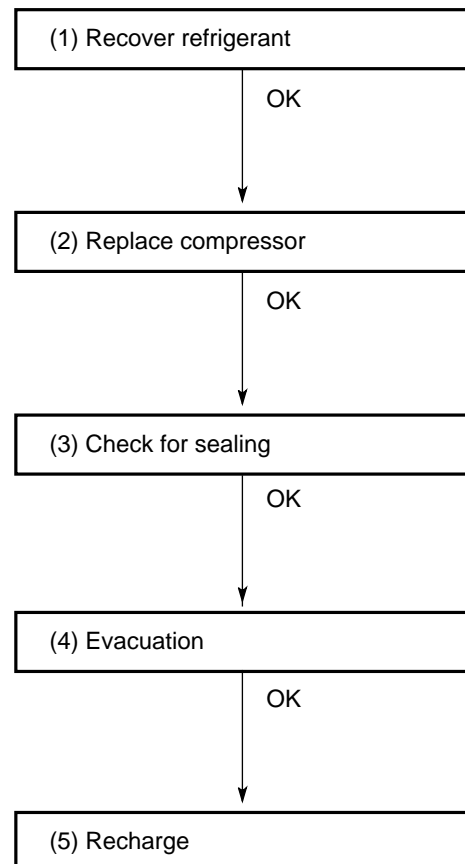

(5) Recharging

- **Be sure to charge the specified amount of refrigerant in liquid state** using the service port of the wide tube service valve. The proper amount is listed on the unit's nameplate.

When the entire amount cannot be charged all at once, charge gradually while operating the unit in Cooling Operation.



CAUTION

Never charge a large amount of liquid refrigerant at once to the unit. This may cause damage to the compressor.

- When charging with a refrigerant cylinder, use an electronic scale for charging refrigerant. In this case, if the volume of refrigerant in the cylinder becomes less than 20% of the fully-charged amount, the composition of the refrigerant starts to change. Thus, **do not use the refrigerant if the amount in the charging cylinder is less than 20%.**

Also, charge the minimum necessary amount to the charging cylinder before using it to charge the air conditioning unit.

Example:

In case of charging refrigerant to a unit requiring 0.76Kg using a capacity of a 10Kg cylinder, the minimum necessary amount for the cylinder is:

$$0.76 + 10 \times 0.20 = 2.76\text{Kg}$$

For the remaining refrigerant, refer to the instructions of the refrigerant manufacturer.

- If using a charging cylinder, transfer the specified amount of liquid refrigerant from the refrigerant cylinder to the charging cylinder.

Prepare an evacuated charging cylinder beforehand.



CAUTION

- **To prevent the composition of R410A from changing, never bleed the refrigerant gas into the atmosphere while transferring the refrigerant. (Fig. 3)**

Do not use the refrigerant if the amount in the charging cylinder is less than 20%.

Configuration and characteristics of cylinders

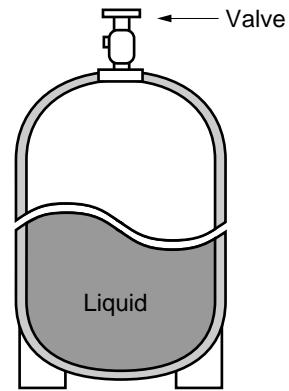

Single valve

Charge liquid refrigerant with cylinder in up-side-down position.

Fig. 1

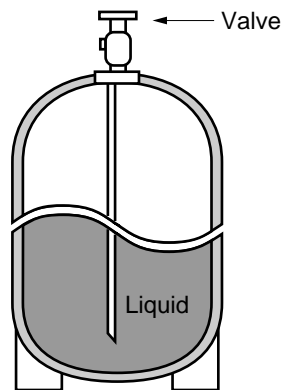

Single valve (with siphon tube)

Charge with cylinder in normal position.

Fig. 2

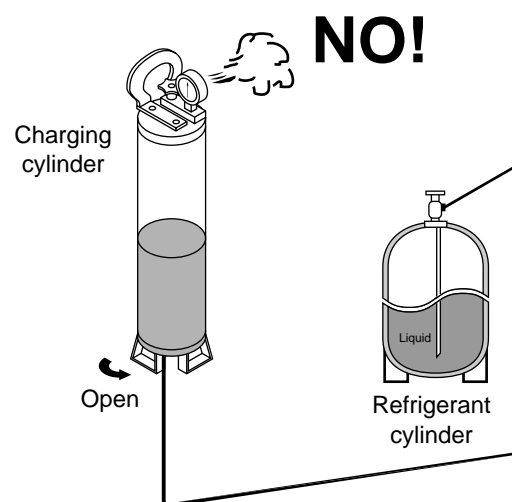

Fig. 3

10-6. In Case Refrigerant is Leaking



CAUTION

Never attempt to charge additional refrigerant when refrigerant has been leaking from the unit. Follow the procedure described below to locate points of leaks and carry out repairs, then recharge the refrigerant.

(1) Detecting Leaks

- Use the detector for R410A to locate refrigerant leak points.

(2) Recovering refrigerant

- Never release the gas to the atmosphere; recover residual refrigerant using the refrigerant recovery unit for R410A, instead.
- Do not reuse the recovered refrigerant because its composition will have been altered.

(3) Welding leaking points

- Confirm again that no residual refrigerant exists in the unit before starting welding.
- Weld securely using flux and wax for R410A.
- Prevent oxide film from forming inside the tubes utilizing substitution with nitrogen (N₂) in the refrigerant circuit of the unit. Leave ends of tubes open during welding.

(4) Checking for sealing

- Use nitrogen gas for the pressurized gas, and never use a refrigerant other than R410A. Also do not use oxygen or any flammable gas.

(5) Evacuation

- **Use a solenoid valve-installed vacuum pump** so that even if power is cut off in the middle of evacuation of air due to a power interruption, the valve will prevent the pump oil from flowing back.
- The equipment may be damaged if moisture remains in the tubing, thus carry out the evacuation thoroughly.
- When using a vacuum pump with exhaust air volume more than 25L/min. and ultimate vacuum pressure rate of 0.05Torr:

Standard time for evacuation

Length of tubing	Less than 10 m	More than 10 m
Time	More than 10 minutes	More than 15 minutes

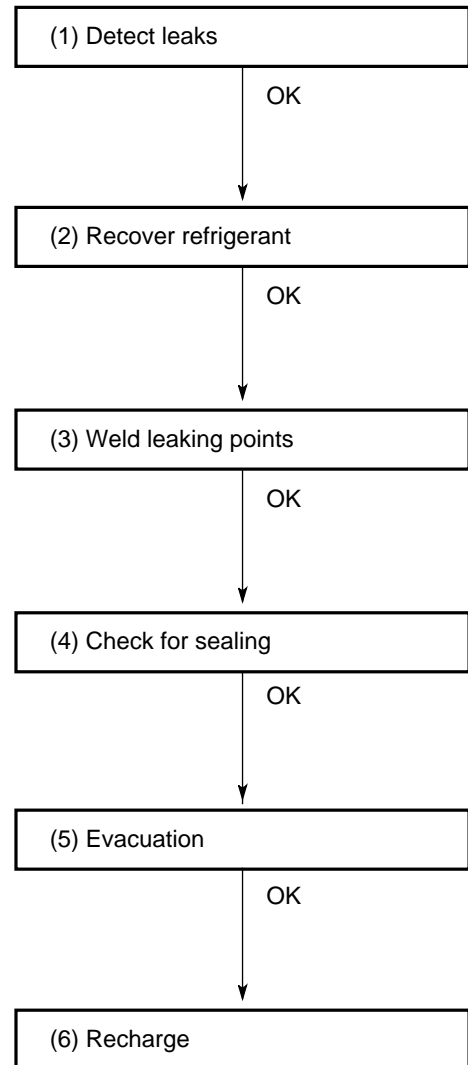

(6) Recharging

- **Be sure to charge the specified amount of refrigerant in liquid state** using the service port of the wide tube service valve. The proper amount is listed on the unit's nameplate.

When the entire amount cannot be charged all at once, charge gradually while operating the unit in Cooling Operation.



CAUTION

Never charge a large amount of liquid refrigerant at once to the unit. This may cause damage to the compressor.

- When charging with a refrigerant cylinder, use an electronic scale for charging refrigerant. In this case, if the volume of refrigerant in the cylinder becomes less than 20% of the fully-charged amount, the composition of the refrigerant starts to change. Thus, **do not use the refrigerant if the amount in the charging cylinder is less than 20%.**

Also, charge the minimum necessary amount to the charging cylinder before using it for charging the air conditioning unit.

Example:

In case of charging refrigerant to a unit requiring 0.76Kg using a capacity of a 10Kg cylinder, the minimum necessary amount for the cylinder is:

$$0.76 + 10 \times 0.20 = 2.76\text{Kg}$$

For the remaining refrigerant, refer to the instructions of the refrigerant manufacturer.

- If using a charging cylinder, transfer the specified amount of liquid refrigerant from the refrigerant cylinder to the charging cylinder.

Prepare an evacuated charging cylinder beforehand.



CAUTION

To prevent the composition of R410A from changing, never bleed the refrigerant gas into the atmosphere while transferring the refrigerant.

Do not use the refrigerant if the amount in the charging cylinder is less than 20%.

Configuration and characteristics of cylinders

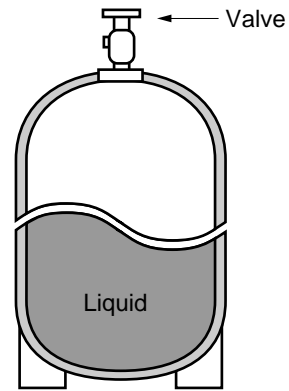

Single valve
Charge liquid refrigerant with cylinder in up-side-down position.

Fig. 4

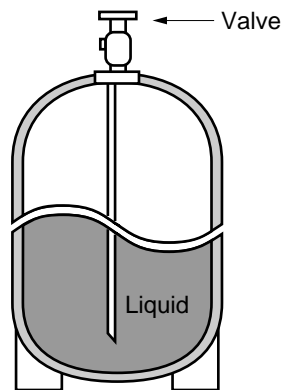

Single valve (with siphon tube)
Charge with cylinder in normal position.

Fig. 5

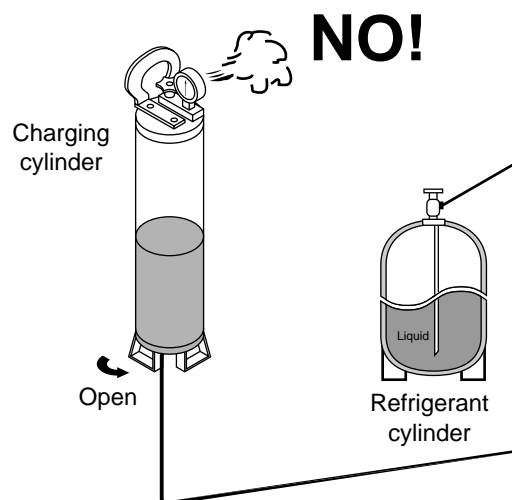

Fig. 6

10-7. Charging Additional Refrigerant

10-7-1. When Tubes are Extended

- Observe the proper amount of refrigerant as stated in this service manual or the installation manual that came with the indoor unit. **Charge additional refrigerant in liquid state only.**



CAUTION

Never charge additional refrigerant if refrigerant is leaking from the unit. Follow instructions given in “10-6. In Case Refrigerant is Leaking” and completely carry out repairs. Only then should you recharge the refrigerant.

10-8. Retro-Fitting Existing Systems

10-8-1. Use of Existing Units

- **Never use new refrigerant R410A for existing units which use R22.** This will cause the air conditioner to operate improperly and may result in a hazardous condition.

10-8-2. Use of Existing Tubing

- If replacing an older unit that used refrigerant R22 with a R410A unit, **do not use its existing tubing.** Instead, completely new tubing must be used.

APPENDIX

UNIT COMBINATION TABLES

NOTE

Be sure to operate the air conditioning system only when 2 or more indoor units have been installed. If operated with only a single unit installed, the returning fluid to the compressor may cause a malfunction.

4-Room Outdoor Unit Combination Table

Outdoor Unit **AE4MI91AH**

NOTE		
2.8:	AWMI28AHL	H
3.6:	AWMI38AHL	
5.0:	AWMI50AHL	
7.0:	AWMI70AHL	

Single-room operation

Indoor Unit Combination	Indoor Unit Capacity (kW)						Power Input (W)	Current (A)
		Room A	Room B	Room C	Room D	Total Performance		
						Min. - Max.		
2.8	Heating	4.0				4.0	1,530	7.2
						1.8 - 5.4	1,170 - 1,760	
	Cooling	2.8				2.8	1,270	6.0
						1.3 - 3.2	990 - 1,360	
3.6	Heating	4.8				4.8	1,660	7.8
						1.9 - 6.3	1,190 - 1,910	
	Cooling	3.6				3.6	1,420	6.7
						1.4 - 3.6	1,010 - 1,430	
5.0	Heating	7.1				7.1	2,040	9.4
						2.0 - 7.8	1,200 - 2,150	
	Cooling	5.0				5.0	1,690	8.0
						1.5 - 5.8	1,030 - 1,850	
7.0	Heating	8.0				8.0	2,150	9.6
						2.0 - 8.8	1,290 - 2,230	
	Cooling	7.0				7.0	1,880	8.9
						1.5 - 8.1	1,120 - 2,040	

2-room operation

Indoor Unit Combination	Indoor Unit Capacity (kW)						Power Input (W)	Current (A)
		Room A	Room B	Room C	Room D	Total Performance		
						Min. - Max.		
2.8+2.8	Heating	4.00	4.00			8.0	2,030	9.3
						1.6 - 9.0	800 - 2,170	
	Cooling	2.80	2.80			5.6	1,710	8.1
						1.1 - 6.7	540 - 1,870	
2.8+3.6	Heating	4.00	4.80			8.8	2,090	9.4
						1.7 - 9.0	820 - 2,170	
	Cooling	2.80	3.60			6.4	1,780	8.4
						1.3 - 7.6	670 - 1,920	
3.6+3.6	Heating	4.80	4.80			9.6	2,130	9.5
						1.7 - 9.8	820 - 2,170	
	Cooling	3.60	3.60			7.2	1,840	8.7
						1.4 - 8.1	720 - 1,940	
2.8+5.0	Heating	3.60	6.40			10.0	2,160	9.6
						1.7 - 10.6	820 - 2,170	
	Cooling	2.80	5.00			7.8	1,880	8.8
						1.4 - 8.1	720 - 1,940	
3.6+5.0	Heating	4.00	6.00			10.0	2,170	9.7
						1.7 - 10.6	820 - 2,170	
	Cooling	3.60	5.00			8.6	1,920	9.0
						1.4 - 10.5	720 - 2,380	
2.8+7.0	Heating	3.35	6.65			10.0	2,170	9.7
						1.7 - 10.8	820 - 2,350	
	Cooling	2.55	6.45			9.0	1,940	8.8
						1.2 - 10.5	620 - 2,380	

Outdoor Unit **AE4MI91AH**

NOTE		
2.8:	AWMI28AHL	H
3.6:	AWMI38AHL	H
5.0:	AWMI50AHL	
7.0:	AWMI70AHL	

3-room operation

Indoor Unit Combination	Indoor Unit Capacity (kW)						Power Input (W) Min. - Max.	Current (A)
		Room A	Room B	Room C	Room D	Total Performance		
						Min. - Max.		
2.8+2.8+2.8	Heating	3.33	3.33	3.33		10.0	2,160	8.7
						1.7 - 10.8	820 - 2,350	
	Cooling	2.80	2.80	2.80		8.4	1,900	8.9
						1.4 - 10.5	720 - 2,380	
2.8+2.8+3.6	Heating	3.10	3.10	3.80		10.0	2,170	9.7
						1.7 - 10.8	820 - 2,350	
	Cooling	2.75	2.75	3.50		9.0	1,940	8.8
						1.2 - 10.5	620 - 2,380	
2.8+2.8+5.0	Heating	2.65	2.65	4.70		10.0	2,170	9.7
						1.7 - 10.8	820 - 2,350	
	Cooling	2.40	2.40	4.20		9.0	1,940	8.8
						1.2 - 10.5	620 - 2,380	
2.8+3.6+3.6	Heating	2.90	3.55	3.55		10.0	2,170	9.7
						1.7 - 10.8	820 - 2,350	
	Cooling	2.50	3.25	3.25		9.0	1,940	8.8
						1.2 - 10.5	620 - 2,380	
3.6+3.6+3.6	Heating	3.33	3.33	3.33		10.0	2,170	9.7
						1.7 - 10.8	820 - 2,350	
	Cooling	3.00	3.00	3.00		9.0	1,940	8.8
						1.2 - 10.5	620 - 2,380	
2.8+3.6+5.0	Heating	2.50	3.00	4.50		10.0	2,170	9.7
						1.7 - 10.8	820 - 2,350	
	Cooling	2.20	2.85	3.95		9.0	1,940	8.8
						1.2 - 10.5	620 - 2,380	
3.6+3.6+5.0	Heating	2.85	2.85	4.30		10.0	2,170	9.7
						1.7 - 10.8	820 - 2,350	
	Cooling	2.65	2.65	3.70		9.0	1,940	8.8
						1.2 - 10.5	620 - 2,380	
2.8+2.8+7.0	Heating	2.50	2.50	5.00		10.0	2,170	9.7
						1.7 - 10.8	820 - 2,350	
	Cooling	2.00	2.00	5.00		9.0	1,940	8.8
						1.2 - 10.5	620 - 2,380	

Outdoor Unit **AE4MI91AH**

NOTE	
2.8:	AWMI28AHL
3.6:	AWMI38AHL
5.0:	AWMI50AHL
7.0:	AWMI70AHL

4-room operation n

Indoor Unit Combination	Indoor Unit Capacity (kW)						Power Input (W) Min. - Max.	Current (A)
		Room A	Room B	Room C	Room D	Total Performance		
						Min. - Max.		
2.8+2.8 2.8+2.8	Heating	2.50	2.50	2.50	2.50	10.0	2,170	9.7
						1.7 - 10.8	820 - 2,350	
	Cooling	2.25	2.25	2.25	2.25	9.0	1,940	8.8
						1.2 - 10.5	620 - 2,380	
2.8+2.8 2.8+3.6	Heating	2.40	2.40	2.40	2.80	10.0	2,170	9.7
						1.7 - 10.8	820 - 2,350	
	Cooling	2.10	2.10	2.10	2.70	9.0	1,940	8.8
						1.2 - 10.5	620 - 2,380	
2.8+2.8 3.6+3.6	Heating	2.25	2.25	2.75	2.75	10.0	2,170	9.7
						1.7 - 10.8	820 - 2,350	
	Cooling	2.00	2.00	2.50	2.50	9.0	1,940	8.8
						1.2 - 10.5	620 - 2,380	
2.8+2.8 2.8+5.0	Heating	2.10	2.10	2.10	3.70	10.0	2,170	9.7
						1.7 - 10.8	820 - 2,350	
	Cooling	1.90	1.90	1.90	3.30	9.0	1,940	8.8
						1.2 - 10.5	620 - 2,380	
2.8+3.6 3.6+3.6	Heating	2.20	2.60	2.60	2.60	10.0	2,170	9.7
						1.7 - 10.8	820 - 2,350	
	Cooling	1.80	2.40	2.40	2.40	9.0	1,940	8.8
						1.2 - 10.5	620 - 2,380	
2.8+2.8 3.6+5.0	Heating	2.00	2.00	2.40	3.60	10.0	2,170	9.7
						1.7 - 10.8	820 - 2,350	
	Cooling	1.75	1.75	2.30	3.20	9.0	1,940	8.8
						1.2 - 10.5	620 - 2,380	
3.6+3.6 3.6+3.6	Heating	2.50	2.50	2.50	2.50	10.0	2,170	9.7
						1.7 - 10.8	820 - 2,350	
	Cooling	2.25	2.25	2.25	2.25	9.0	1,940	8.8
						1.2 - 10.5	620 - 2,380	
2.8+3.6 3.6+5.0	Heating	1.95	2.30	2.30	3.45	10.0	2,170	9.7
						1.7 - 10.8	820 - 2,350	
	Cooling	1.70	2.15	2.15	3.00	9.0	1,940	8.8
						1.2 - 10.5	620 - 2,380	
2.8+2.8 2.8+7.0	Heating	2.00	2.00	2.00	4.00	10.0	2,170	9.7
						1.7 - 10.8	820 - 2,350	
	Cooling	1.65	1.65	1.65	4.05	9.0	1,940	8.8
						1.2 - 10.5	620 - 2,380	



ARGOCLIMA SPA
GALLARATE-ITALY